

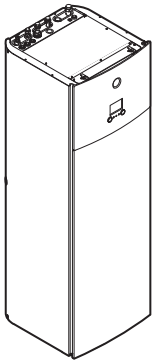

Installer reference guide

R32 Split Series - Domestic Hot Water Tank (230I)



CKHWSU230BJ ▲V3 ▼

▲ = 1, 2, 3, ..., 9, A, B, C, ..., Z
▼ = , 1, 2, 3, ..., 9

Table of contents

1	About this document	5
1.1	Meaning of warnings and symbols	6
1.2	Installer reference guide at a glance.....	7
2	General safety precautions	9
2.1	For the installer	9
2.1.1	General.....	9
2.1.2	Installation site.....	10
2.1.3	Refrigerant — in case of R410A or R32.....	10
2.1.4	Water	12
2.1.5	Electrical.....	12
3	Specific installer safety instructions	15
4	About the box	21
4.1	Indoor unit.....	21
4.1.1	To unpack the indoor unit	21
4.1.2	To remove the accessories from the indoor unit.....	21
4.1.3	To handle the indoor unit.....	22
4.2	Domestic hot water tank kit.....	22
4.2.1	To remove the accessories from the domestic hot water tank kit.....	22
4.3	Checklist for the required DHW accessories	22
5	About the units and options	24
5.1	Identification	24
5.1.1	Identification label: Indoor unit.....	24
5.2	Combining units and options	24
5.2.1	Possible combinations of indoor unit and outdoor unit.....	24
5.2.2	Possible options for the indoor unit.....	25
6	Application guidelines	26
6.1	Overview: Application guidelines.....	26
6.2	Setting up the domestic hot water tank	26
6.2.1	System layout – Standalone DHW tank.....	26
6.2.2	Selecting the volume and desired temperature for the DHW tank	27
6.2.3	Setup and configuration – DHW tank.....	28
6.2.4	DHW pump for instant hot water.....	28
6.2.5	DHW pump for disinfection.....	29
6.3	Setting up the energy metering	29
6.3.1	Produced heat.....	30
6.3.2	Consumed energy.....	30
6.3.3	Normal kWh rate power supply	30
6.4	Setting up the power consumption control	31
6.4.1	Permanent power limitation	31
6.4.2	Power limitation process	32
7	Unit installation	33
7.1	Preparing the installation site	33
7.1.1	Installation site requirements of the indoor unit.....	33
7.1.2	Special requirements for R32 units	34
7.1.3	Installation patterns.....	36
7.2	Opening and closing the units.....	44
7.2.1	About opening the units.....	44
7.2.2	To open the indoor unit.....	44
7.2.3	To lower the switch box.....	46
7.2.4	To close the indoor unit.....	47
7.3	Mounting the indoor unit.....	47
7.3.1	About mounting the indoor unit	47
7.3.2	Precautions when mounting the indoor unit.....	47
7.3.3	To connect the drain hose to the drain.....	47
7.3.4	To install the indoor unit	48
8	Piping installation	50
8.1	Preparing refrigerant piping.....	50
8.1.1	Refrigerant piping requirements	50
8.1.2	Refrigerant piping insulation for the indoor unit.....	51
8.2	Connecting the refrigerant piping.....	51

8.2.1	About connecting the refrigerant piping	51
8.2.2	Precautions when connecting the refrigerant piping	52
8.2.3	To connect the refrigerant piping to the indoor unit	52
8.3	Checking the refrigerant piping	53
8.3.1	About checking the refrigerant piping	53
8.3.2	Precautions when checking the refrigerant piping	53
8.3.3	Checking refrigerant piping: Setup	54
8.3.4	To check for leaks	54
8.3.5	To perform vacuum drying	54
8.4	Charging refrigerant	55
8.5	Preparing water piping	55
8.5.1	To check the flow rate	56
8.5.2	Water circuit requirements	56
8.5.3	Formula to calculate the expansion vessel pre-pressure	59
8.5.4	Changing the pre-pressure of the expansion vessel	59
8.6	Connecting water piping	59
8.6.1	About connecting the water piping	59
8.6.2	Precautions when connecting the water piping	60
8.6.3	To connect the water piping	60
8.6.4	To connect the water piping for domestic hot water	61
8.6.5	To connect the recirculation piping	64
8.6.6	To fill the heating circuit for domestic hot water	64
8.6.7	To fill the domestic hot water tank	65
8.6.8	To insulate the water piping	65
9	Electrical installation	66
9.1	About connecting the electrical wiring	66
9.1.1	Precautions when connecting the electrical wiring	66
9.1.2	Guidelines when connecting the electrical wiring	67
9.1.3	About electrical compliance	68
9.2	Connections to the indoor unit	69
9.2.1	To connect the main power supply	69
9.2.2	To connect the backup heater power supply	70
9.2.3	To connect the electricity meters	71
9.2.4	To connect the domestic hot water pump	72
9.3	After connecting the electrical wiring to the indoor unit	73
10	Configuration	74
10.1	Overview: Configuration	74
10.1.1	To access the most used commands	75
10.1.2	To connect the PC cable to the switch box	77
10.2	Configuration wizard	77
10.3	Possible screens	78
10.3.1	Possible screens: Overview	78
10.3.2	Home screen	79
10.3.3	Main menu screen	80
10.3.4	Menu screen	81
10.3.5	Setpoint screen	81
10.3.6	Detailed screen with values	82
10.4	Preset values and schedules	83
10.4.1	Using preset values	83
10.4.2	Using and programming schedules	83
10.4.3	Schedule screen: Example	85
10.5	Weather-dependent curve	88
10.5.1	What is a weather-dependent curve?	88
10.5.2	Slope-offset curve	89
10.5.3	2-points curve	90
10.5.4	Using weather-dependent curves	91
10.6	Settings menu	92
10.6.1	Malfunctioning	92
10.6.2	Tank	92
10.6.3	User settings	101
10.6.4	Information	104
10.6.5	Installer settings	105
10.6.6	Commissioning	111
10.6.7	User profile	111
10.6.8	Operation	111
10.6.9	WLAN	112
10.7	Menu structure: Overview user settings	115
10.8	Menu structure: Overview installer settings	116

11 Commissioning	117
11.1 Overview: Commissioning	117
11.2 Precautions when commissioning	118
11.3 Checklist before commissioning	118
11.4 Checklist during commissioning	119
11.4.1 Minimum flow rate	119
11.4.2 Air purge function	120
11.4.3 Operation test run	121
11.4.4 Actuator test run	122
12 Hand-over to the user	123
13 Maintenance and service	124
13.1 Maintenance safety precautions	124
13.2 Yearly maintenance	124
13.2.1 Yearly maintenance indoor unit: overview	124
13.2.2 Yearly maintenance indoor unit: instructions	125
13.3 To drain the domestic hot water tank	127
13.4 To inspect the inside of the domestic hot water tank	128
14 Troubleshooting	130
14.1 Overview: Troubleshooting	130
14.2 Precautions when troubleshooting	130
14.3 Solving problems based on symptoms	131
14.3.1 Symptom: Hot water does NOT reach the desired temperature	131
14.3.2 Symptom: The compressor does NOT start	131
14.3.3 Symptom: The system is making gurgling noises after commissioning	131
14.3.4 Symptom: The pump is blocked	132
14.3.5 Symptom: The pump is making noise (cavitation)	132
14.3.6 Symptom: The pressure relief valve opens	133
14.3.7 Symptom: The water pressure relief valve leaks	133
14.3.8 Symptom: The pressure at the tapping point is temporarily unusually high	133
14.3.9 Symptom: Tank disinfection function is NOT completed correctly (AH-error)	133
14.4 Solving problems based on error codes	134
14.4.1 To display the help text in case of a malfunction	134
14.4.2 Error codes: Overview	135
15 Disposal	139
16 Technical data	140
16.1 Piping diagram: Indoor unit	141
16.2 Wiring diagram: Indoor unit	142
16.3 ESP curve: Indoor unit	145
16.4 Technical specifications: Domestic hot water tank	145
16.4.1 Test results in accordance with EN12897 (2016)	145
16.4.2 Warning label	146
17 Glossary	147
18 Field settings table	148

1 About this document

Target audience

Authorised installers

Documentation set

This document is part of a documentation set. The complete set consists of:

▪ General safety precautions:

- Safety instructions that you must read before installing
- Format: Paper (in the box of the indoor unit)

▪ Operation manual:

- Quick guide for basic usage
- Format: Paper (in the box of the indoor unit)

▪ User reference guide:

- Detailed step-by-step instructions and background information for basic and advanced usage
- Format: Digital files on <https://www.daikin.eu>. Use the search function 🔍 to find your model.

▪ Installation manual – Outdoor unit:

- Installation instructions
- Format: Paper (in the box of the outdoor unit)

▪ Installation manual – Indoor unit:

- Installation instructions
- Format: Paper (in the box of the indoor unit)

▪ Installer reference guide:

- Preparation of the installation, good practices, reference data, ...
- Format: Digital files on <https://www.daikin.eu>. Use the search function 🔍 to find your model.

The latest revision of the supplied documentation is published on the regional Daikin website and is available via your dealer.

The original instructions are written in English. All other languages are translations of the original instructions.

Technical engineering data

- A **subset** of the latest technical data is available on the regional Daikin website (publicly accessible).
- The **full set** of the latest technical data is available on the Daikin Business Portal (authentication required).

Online tools

In addition to the documentation set, some online tools are available for installers:

▪ Daikin Technical Data Hub

- Central hub for technical specifications of the unit, useful tools, digital resources, and more.
- Publicly accessible via <https://daikintechdatahub.eu>.

▪ **Heating Solutions Navigator**

- Digital toolbox that offers a variety of tools to facilitate the installation and configuration of heating systems.
- To access the Heating Solutions Navigator, registration to the Stand By Me platform is required. For more information, see <https://professional.standbyme.daikin.eu>.

▪ **Daikin e-Care**

- Mobile app for installers and service technicians that allows you to register, configure and troubleshoot heating systems.
- Use the QR codes below to download the mobile app for iOS and Android devices. Registration to the Stand By Me platform is required to access the app.

App Store



Google Play



1.1 Meaning of warnings and symbols



DANGER

Indicates a situation that results in death or serious injury.



DANGER: RISK OF ELECTROCUTION

Indicates a situation that could result in electrocution.



DANGER: RISK OF BURNING/SCALDING

Indicates a situation that could result in burning/scalding because of extreme hot or cold temperatures.



DANGER: RISK OF EXPLOSION

Indicates a situation that could result in explosion.



WARNING

Indicates a situation that could result in death or serious injury.



WARNING: FLAMMABLE MATERIAL



CAUTION

Indicates a situation that could result in minor or moderate injury.



NOTICE





Indicates a situation that could result in equipment or property damage.





INFORMATION

Indicates useful tips or additional information.

Symbols used on the unit:

Symbol	Explanation
	Before installation, read the installation and operation manual, and the wiring instruction sheet.
	Before performing maintenance and service tasks, read the service manual.
	For more information, see the installer and user reference guide.
	The unit contains rotating parts. Be careful when servicing or inspecting the unit.

Symbols used in the documentation:

Symbol	Explanation
	Indicates a figure title or a reference to it. Example: "▲ 1-3 Figure title" means "Figure 3 in chapter 1".
	Indicates a table title or a reference to it. Example: "■ 1-3 Table title" means "Table 3 in chapter 1".

1.2 Installer reference guide at a glance

Chapter	Description
About the documentation	What documentation exists for the installer
General safety precautions	Safety instructions that you must read before installing
Specific installer safety instructions	
About the box	How to handle the box, unpack the units and remove their accessories
About the units and options	<ul style="list-style-type: none"> ▪ How to identify the units ▪ Possible combinations of units and options
Application guidelines	Various installation setups of the system
Unit installation	What to do and know to install the system, including information on how to prepare for an installation
Piping installation	What to do and know to install the piping of the system, including information on how to prepare for an installation
Electrical installation	What to do and know to install the electrical components of the system, including information on how to prepare for an installation
Finishing the outdoor unit installation	What to do after unit installation, piping installation and electrical installation
Configuration	What to do and know to configure the system after it is installed

Chapter	Description
Commissioning	What to do and know to commission the system after it is configured
Hand-over to the user	What to give and explain to the user
Maintenance and service	How to maintain and service the units
Troubleshooting	What to do in case of problems
Disposal	How to dispose of the system
Technical data	Specifications of the system
Glossary	Definition of terms
Field settings table	Table to be filled in by the installer, and kept for future reference Note: There is also an installer settings table in the user reference guide. This table has to be filled in by the installer and handed over to the user.

2 General safety precautions

In this chapter

2.1	For the installer.....	9
2.1.1	General.....	9
2.1.2	Installation site.....	10
2.1.3	Refrigerant — in case of R410A or R32.....	10
2.1.4	Water.....	12
2.1.5	Electrical.....	12

2.1 For the installer

2.1.1 General

If you are NOT sure how to install or operate the unit, contact your dealer.



DANGER: RISK OF BURNING/SCALDING

- Do NOT touch the refrigerant piping, water piping or internal parts during and immediately after operation. It could be too hot or too cold. Give it time to return to normal temperature. If you MUST touch it, wear protective gloves.
- Do NOT touch any accidental leaking refrigerant.



WARNING

Improper installation or attachment of equipment or accessories could result in electrical shock, short-circuit, leaks, fire or other damage to the equipment. ONLY use accessories, optional equipment and spare parts made or approved by Daikin unless otherwise specified.



WARNING

Make sure installation, testing and applied materials comply with applicable legislation (on top of the instructions described in the Daikin documentation).



WARNING

Tear apart and throw away plastic packaging bags so that nobody, especially children, can play with them. **Possible consequence:** suffocation.



WARNING

Provide adequate measures to prevent that the unit can be used as a shelter by small animals. Small animals that make contact with electrical parts can cause malfunctions, smoke or fire.



CAUTION

Wear adequate personal protective equipment (protective gloves, safety glasses,...) when installing, maintaining or servicing the system.



CAUTION

Do NOT touch the air inlet or aluminium fins of the unit.



CAUTION

- Do NOT place any objects or equipment on top of the unit.
- Do NOT sit, climb or stand on the unit.

In accordance with the applicable legislation, it might be necessary to provide a logbook with the product containing at least: information on maintenance, repair work, results of tests, stand-by periods,...

Also, at least, following information MUST be provided at an accessible place at the product:

- Instructions for shutting down the system in case of an emergency
- Name and address of fire department, police and hospital
- Name, address and day and night telephone numbers for obtaining service

In Europe, EN378 provides the necessary guidance for this logbook.

2.1.2 Installation site

- Provide sufficient space around the unit for servicing and air circulation.
- Make sure the installation site withstands the weight and vibration of the unit.
- Make sure the area is well ventilated. Do NOT block any ventilation openings.
- Make sure the unit is level.

Do NOT install the unit in the following places:

- In potentially explosive atmospheres.
- In places where there is machinery that emits electromagnetic waves. Electromagnetic waves may disturb the control system, and cause malfunction of the equipment.
- In places where there is a risk of fire due to the leakage of flammable gases (example: thinner or gasoline), carbon fibre, ignitable dust.
- In places where corrosive gas (example: sulphurous acid gas) is produced. Corrosion of copper pipes or soldered parts may cause the refrigerant to leak.

2.1.3 Refrigerant — in case of R410A or R32

If applicable. See the installation manual or installer reference guide of your application for more information.



DANGER: RISK OF EXPLOSION

Pump down – Refrigerant leakage. If you want to pump down the system, and there is a leak in the refrigerant circuit:

- Do NOT use the unit's automatic pump down function, with which you can collect all refrigerant from the system into the outdoor unit. **Possible consequence:** Self-combustion and explosion of the compressor because of air going into the operating compressor.
- Use a separate recovery system so that the unit's compressor does NOT have to operate.



WARNING

During tests, NEVER pressurise the product with a pressure higher than the maximum allowable pressure (as indicated on the nameplate of the unit).



WARNING

Take sufficient precautions in case of refrigerant leakage. If refrigerant gas leaks, ventilate the area immediately. Possible risks:

- Excessive refrigerant concentrations in a closed room can lead to oxygen deficiency.
- Toxic gas might be produced if refrigerant gas comes into contact with fire.



WARNING

ALWAYS recover the refrigerant. Do NOT release them directly into the environment. Use a vacuum pump to evacuate the installation.



WARNING

Make sure there is no oxygen in the system. Refrigerant may ONLY be charged after performing the leak test and the vacuum drying.

Possible consequence: Self-combustion and explosion of the compressor because of oxygen going into the operating compressor.



NOTICE

- To avoid compressor breakdown, do NOT charge more than the specified amount of refrigerant.
- When the refrigerant system is to be opened, refrigerant MUST be treated according to the applicable legislation.



NOTICE

Make sure refrigerant piping installation complies with applicable legislation. In Europe, EN378 is the applicable standard.



NOTICE

Make sure the field piping and connections are NOT subjected to stress.



NOTICE

After all the piping has been connected, make sure there is no gas leak. Use nitrogen to perform a gas leak detection.

- In case recharge is required, see the nameplate or the refrigerant charge label of the unit. It states the type of refrigerant and necessary amount.
- Whether the unit is factory charged with refrigerant or non-charged, in both cases you might need to charge additional refrigerant, depending on the pipe sizes and pipe lengths of the system.
- ONLY use tools exclusively for the refrigerant type used in the system, this to ensure pressure resistance and prevent foreign materials from entering into the system.
- Charge the liquid refrigerant as follows:

If	Then
A siphon tube is present (i.e., the cylinder is marked with "Liquid filling siphon attached")	Charge with the cylinder upright. 

If	Then
A siphon tube is NOT present	Charge with the cylinder upside down. 

- Open refrigerant cylinders slowly.
- Charge the refrigerant in liquid form. Adding it in gas form may prevent normal operation.



CAUTION

When the refrigerant charging procedure is done or when pausing, close the valve of the refrigerant tank immediately. If the valve is NOT closed immediately, remaining pressure might charge additional refrigerant. **Possible consequence:** Incorrect refrigerant amount.

2.1.4 Water

If applicable. See the installation manual or installer reference guide of your application for more information.



NOTICE

Make sure water quality complies with EU directive 2020/2184.

2.1.5 Electrical



DANGER: RISK OF ELECTROCUTION

- Turn OFF all power supply before removing the switch box cover, connecting electrical wiring or touching electrical parts.
- Disconnect the power supply for more than 10 minutes, and measure the voltage at the terminals of main circuit capacitors or electrical components before servicing. The voltage MUST be less than 50 V DC before you can touch electrical components. For the location of the terminals, see the wiring diagram.
- Do NOT touch electrical components with wet hands.
- Do NOT leave the unit unattended when the service cover is removed.



WARNING

If NOT factory installed, a main switch or other means for disconnection, having a contact separation in all poles providing full disconnection under overvoltage category III condition, MUST be installed in the fixed wiring.

**WARNING**

- ONLY use copper wires.
- Make sure the field wiring complies with the national wiring regulations.
- All field wiring **MUST** be performed in accordance with the wiring diagram supplied with the product.
- NEVER squeeze bundled cables and make sure they do NOT come in contact with the piping and sharp edges. Make sure no external pressure is applied to the terminal connections.
- Make sure to install earth wiring. Do NOT earth the unit to a utility pipe, surge absorber, or telephone earth. Incomplete earth may cause electrical shock.
- Make sure to use a dedicated power circuit. NEVER use a power supply shared by another appliance.
- Make sure to install the required fuses or circuit breakers.
- Make sure to install an earth leakage protector. Failure to do so may cause electrical shock or fire.
- When installing the earth leakage protector, make sure it is compatible with the inverter (resistant to high frequency electric noise) to avoid unnecessary opening of the earth leakage protector.

**WARNING**

- After finishing the electrical work, confirm that each electrical component and terminal inside the switch box is connected securely.
- Make sure all covers are closed before starting up the unit.

**CAUTION**

- When connecting the power supply: connect the earth cable first, before making the current-carrying connections.
- When disconnecting the power supply: disconnect the current-carrying cables first, before separating the earth connection.
- The length of the conductors between the power supply stress relief and the terminal block itself **MUST** be as such that the current-carrying wires are tautened before the earth wire is in case the power supply is pulled loose from the stress relief.

**NOTICE**

Precautions when laying power wiring:



- Do NOT connect wiring of different thicknesses to the power terminal block (slack in the power wiring may cause abnormal heat).
- When connecting wiring which is the same thickness, do as shown in the figure above.
- For wiring, use the designated power wire and connect firmly, then secure to prevent outside pressure being exerted on the terminal board.
- Use an appropriate screwdriver for tightening the terminal screws. A screwdriver with a small head will damage the head and make proper tightening impossible.
- Over-tightening the terminal screws may break them.

Install power cables at least 1 meter away from televisions or radios to prevent interference. Depending on the radio waves, a distance of 1 meter may NOT be sufficient.

**NOTICE**

ONLY applicable if the power supply is three-phase, and the compressor has an ON/OFF starting method.

If there exists the possibility of reversed phase after a momentary black out and the power goes ON and OFF while the product is operating, attach a reversed phase protection circuit locally. Running the product in reversed phase can break the compressor and other parts.

3 Specific installer safety instructions

Always observe the following safety instructions and regulations.

Application guidelines (see "6 Application guidelines" [▶ 26])



CAUTION

If there is more than one leaving water zone, ALWAYS install a mixing valve station in the main zone to decrease (in heating)/increase (in cooling) the leaving water temperature when the additional zone has demand.

Installation site (see "7.1 Preparing the installation site" [▶ 33])



WARNING

Follow the service space dimensions in this manual to install the unit correctly. See "7.1.1 Installation site requirements of the indoor unit" [▶ 33].



WARNING

The appliance shall be stored in a room without continuously operating ignition sources (example: open flames, an operating gas appliance or an operating electric heater).



WARNING

DO NOT reuse refrigerant piping that has been used with any other refrigerant. Replace the refrigerant pipes or clean thoroughly.

Special requirements for R32 (see "7.1.2 Special requirements for R32 units" [▶ 34])



WARNING

- Do NOT pierce or burn refrigerant cycle parts.
- Do NOT use means to accelerate the defrosting process or to clean the equipment, other than those recommended by the manufacturer.
- Be aware that R32 refrigerant does NOT contain an odour.



WARNING

The appliance shall be stored so as to prevent mechanical damage and in a well-ventilated room without continuously operating ignition sources (example: open flames, an operating gas appliance or an operating electric heater).



WARNING

Make sure installation, servicing, maintenance and repair comply with instructions from Daikin and with applicable legislation (for example national gas regulation) and are executed ONLY by authorised persons.



WARNING

For units using the R32 refrigerant it is necessary to keep any required ventilation openings and chimneys clear of obstructions.

Opening and closing the unit (see "7.2 Opening and closing the units" [▶ 44])

**DANGER: RISK OF ELECTROCUTION**

Do NOT leave the unit unattended when the service cover is removed.

**DANGER: RISK OF ELECTROCUTION****DANGER: RISK OF BURNING/SCALDING**

Mounting the indoor unit (see "7.3 Mounting the indoor unit" [▶ 47])

**WARNING**

Fixing method of the indoor unit MUST be in accordance with the instructions from this manual. See "7.3 Mounting the indoor unit" [▶ 47].

Piping installation (see "8 Piping installation" [▶ 50])

**WARNING**

Field piping MUST be in accordance with the instructions from this manual. See "8 Piping installation" [▶ 50].

**WARNING**

The discharge pipes from the pressure relief valves MUST terminate in a safe and visible position without forming any risk to persons in the vicinity.

**WARNING**

- Discharge piping, tundish, drain valves, etc. MUST be positioned away from any electrical components.
- The discharge pipe away from the tundish MUST terminate in a safe, visible position without forming any risk to persons in the vicinity.

**WARNING**

- Do NOT install any valves between the domestic hot water tank and relief valves/ expansion vessel.
- Do NOT install shut-off valves between the expansion relief valve and the domestic hot water tank.

**DANGER: RISK OF BURNING/SCALDING****CAUTION**

- Incomplete flaring may cause refrigerant gas leakage.
- Do NOT re-use flares. Use new flares to prevent refrigerant gas leakage.
- Use flare nuts that are included with the unit. Using different flare nuts may cause refrigerant gas leakage.

**WARNING**

Provide adequate measures to prevent that the unit can be used as a shelter by small animals. Small animals that make contact with electrical parts can cause malfunctions, smoke or fire.

**WARNING**

Some sections of the refrigerant circuit may be isolated from other sections caused by components with specific functions (e.g. valves). The refrigerant circuit therefore features additional service ports for vacuuming, pressure relief or pressurizing the circuit.

In case it is required to perform **brazing** on the unit, ensure that there is no pressure remaining inside the unit. Internal pressures need to be released with ALL the service ports indicated on the figures below opened. The location is depending on model type.

**WARNING**

- Only use R32 as refrigerant. Other substances may cause explosions and accidents.
- R32 contains fluorinated greenhouse gases. Its global warming potential (GWP) value is 675. Do NOT vent these gases into the atmosphere.
- When charging refrigerant, ALWAYS use protective gloves and safety glasses.

Electrical installation (see "9 Electrical installation" [▶ 66])**DANGER: RISK OF ELECTROCUTION****WARNING**

Electrical wiring MUST be in accordance with the instructions from:

- This manual. See "9 Electrical installation" [▶ 66].
- The wiring diagram, which is delivered with the unit, located on the inside of the indoor unit switch box cover. For a translation of its legend, see "16.2 Wiring diagram: Indoor unit" [▶ 142].

**WARNING**

- All wiring MUST be performed by an authorised electrician and MUST comply with the national wiring regulation.
- Make electrical connections to the fixed wiring.
- All components procured on-site and all electrical construction MUST comply with the applicable legislation.



WARNING

- If the power supply has a missing or wrong N-phase, equipment might break down.
- Establish proper earthing. Do NOT earth the unit to a utility pipe, surge absorber, or telephone earth. Incomplete earthing may cause electrical shocks.
- Install the required fuses or circuit breakers.
- Secure the electrical wiring with cable ties so that the cables do NOT come in contact with sharp edges or piping, particularly on the high-pressure side.
- Do NOT use taped wires, extension cords, or connections from a star system. They can cause overheating, electrical shocks or fire.
- Do NOT install a phase advancing capacitor, because this unit is equipped with an inverter. A phase advancing capacitor will reduce performance and may cause accidents.



WARNING

If the supply cord is damaged, it MUST be replaced by the manufacturer, its service agent or similarly qualified persons in order to avoid a hazard.



WARNING

ALWAYS use multicore cable for power supply cables.



CAUTION

Do NOT push or place redundant cable length into the unit.



WARNING

Make sure that the electrical wiring does NOT touch the refrigerant gas pipe, which can be very hot.

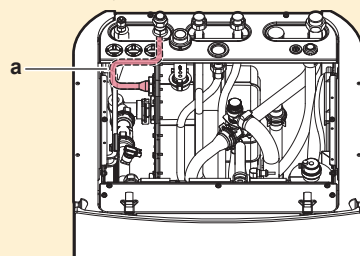

a Refrigerant gas pipe



WARNING

The backup heater MUST have a dedicated power supply and MUST be protected by the safety devices required by the applicable legislation.



CAUTION

To guarantee the unit is completely earthed, ALWAYS connect the backup heater power supply and the earth cable.

Configuration (see "10 Configuration" [▶ 74])



CAUTION

The disinfection function settings MUST be configured by the installer according to the applicable legislation.

**WARNING**

Be aware that the domestic hot water temperature at the hot water tap will be equal to the value selected in field setting [2-03] after a disinfection operation.

When the high domestic hot water temperature can be a potential risk for human injuries, a mixing valve (field supply) shall be installed at the hot water outlet connection of the domestic hot water tank. This mixing valve shall secure that the hot water temperature at the hot water tap never rise above a set maximum value. This maximum allowable hot water temperature shall be selected according to the applicable legislation.

**CAUTION**

Make sure that the disinfection function start time [5.7.3] with defined duration [5.7.5] is NOT interrupted by possible domestic hot water demand.

Commissioning (see "11 Commissioning" [▶ 117])**WARNING**

Commissioning MUST be in accordance with the instructions from this manual. See "11 Commissioning" [▶ 117].

Maintenance and service (see "13 Maintenance and service" [▶ 124])**DANGER: RISK OF ELECTROCUTION****DANGER: RISK OF BURNING/SCALDING****CAUTION**

Water coming out of the valve may be very hot.

**WARNING**

If the internal wiring is damaged, it has to be replaced by the manufacturer, its service agent or similarly qualified persons.

**DANGER: RISK OF BURNING/SCALDING**

The water in the tank can be very hot.

Troubleshooting (see "14 Troubleshooting" [▶ 130])**DANGER: RISK OF ELECTROCUTION****DANGER: RISK OF BURNING/SCALDING**



WARNING

- When carrying out an inspection on the switch box of the unit, ALWAYS make sure that the unit is disconnected from the mains. Turn off the respective circuit breaker.
- When a safety device was activated, stop the unit and find out why the safety device was activated before resetting it. NEVER shunt safety devices or change their values to a value other than the factory default setting. If you are unable to find the cause of the problem, call your dealer.





WARNING

Prevent hazards due to inadvertent resetting of the thermal cut-out: power to this appliance MUST NOT be supplied through an external switching device, such as a timer, or connected to a circuit that is regularly turned ON and OFF by the utility.



WARNING

Air purging heating circuit for domestic hot water. Before you purge air, check if  or  is displayed on the home screen of the user interface.

- If not, you can purge air immediately.
- If yes, make sure that the room where you want to purge air is sufficiently ventilated. **Reason:** In case of a breakdown, refrigerant might leak into the water circuit, and subsequently into the room when you purge air from the heating circuit of the domestic hot water.

4 About the box

Keep the following in mind:

- At delivery, the unit **MUST** be checked for damage and completeness. Any damage or missing parts **MUST** be reported immediately to the claims agent of the carrier.
- Bring the packed unit as close as possible to its final installation position to prevent damage during transport.
- Prepare in advance the path along which you want to bring the unit to its final installation position.

4.1 Indoor unit

4.1.1 To unpack the indoor unit

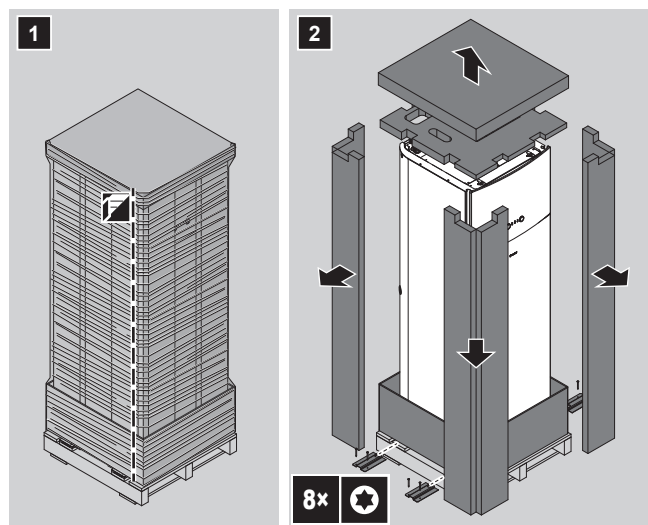

4.1.2 To remove the accessories from the indoor unit

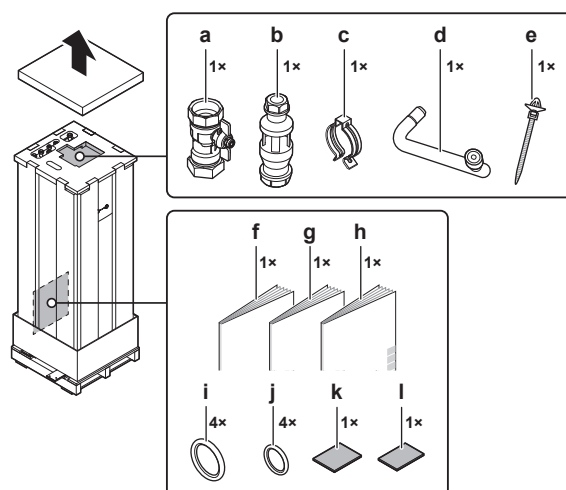

- a** Shut-off valve for water circuit
- b** Tundish (to mount onto the pressure relief valve discharge pipe)
- c** Quick fixture (for the discharge pipe)
- d** Discharge pipe (for pressure relief valve)
- e** Cable tie + clip (for the discharge pipe)
- f** General safety precautions
- g** Indoor unit installation manual
- i** 4x
- j** 4x
- k** 1x
- l** 1x

- h** Operation manual
- i** Sealing rings for shut-off valves (water circuit)
- j** Sealing rings for field-supplied shut-off valves (domestic hot water circuit)
- k** Sealing tape for low voltage wiring intake (66×80 mm)
- l** Antisweat sticker to cover the hole at the back of the unit (50×80 mm)

4.1.3 To handle the indoor unit

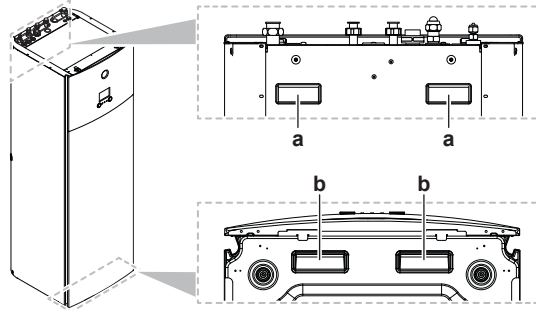

- a** Handles at the back of the unit
- b** Handles at the bottom of the unit. Carefully tilt the unit backwards so that the handles become visible.

4.2 Domestic hot water tank kit

4.2.1 To remove the accessories from the domestic hot water tank kit

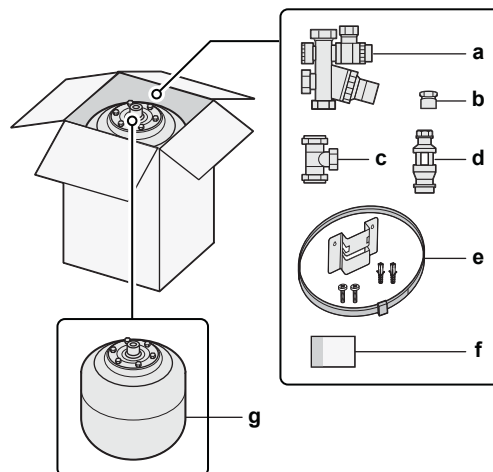

- a** Pressure reducing valve/pressure relief valve combination. Water inlet and water outlet 22 mm connection, discharge piping connection 15 mm
- b** Adaptor 22 mm×3/4" Female BSP
- c** T-piece 22 mm×22 mm×22 mm
- d** Tundish 15 mm inlet, 22 mm outlet
- e** Wall mounting set for expansion vessel
- f** Instruction sheet
- g** Expansion vessel of 18 l – 3/4" Male BSP



NOTICE

All piping **MUST** be installed according to section G3 of the Building Regulations.

4.3 Checklist for the required DHW accessories

For installation compliant with section G3 of the Building Regulations, you must verify that the following accessories are present.

Delivered with indoor unit:

<input type="checkbox"/>	Tundish 15 mm inlet, 22 mm outlet
--------------------------	-----------------------------------

Delivered with domestic hot water tank kit:

<input type="checkbox"/>	Pressure reducing valve/pressure relief valve combination
<input type="checkbox"/>	Adaptor 22 mm×3/4" Female BSP
<input type="checkbox"/>	T-piece 22 mm×22 mm×22 mm
<input type="checkbox"/>	Tundish 15 mm inlet, 22 mm outlet
<input type="checkbox"/>	Wall mounting set for expansion vessel
<input type="checkbox"/>	Instruction sheet
<input type="checkbox"/>	Expansion vessel of 18 l – 3/4" Male BSP

5 About the units and options

In this chapter

5.1	Identification.....	24
5.1.1	Identification label: Indoor unit.....	24
5.2	Combining units and options.....	24
5.2.1	Possible combinations of indoor unit and outdoor unit.....	24
5.2.2	Possible options for the indoor unit.....	25

5.1 Identification

5.1.1 Identification label: Indoor unit

Location

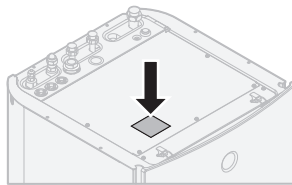

Model identification

Example: C K HW S U 180 BJ V3

Code	Description
C	Residential multi compatible model
K	Kit
HW	Domestic Hot Water
S	Integrated tank material: Stainless steel
U	Variant for the UK
180	Volume in litre
BJ	Model series
V3	Backup heater model: 1~ / 230 V / 50 Hz

5.2 Combining units and options



INFORMATION

Certain options may NOT be available in your country.

5.2.1 Possible combinations of indoor unit and outdoor unit

Indoor unit	Outdoor unit	
	5MWXM90	5MWXM68
CKHWSU230	O	O

5.2.2 Possible options for the indoor unit

PC cable (EKPCAB4)

The PC cable makes a connection between the switch box of the indoor unit and a PC. It gives the possibility to update the software of the indoor unit.

For installation instructions, see:

- the installation manual of the PC cable
- "[10.1.2 To connect the PC cable to the switch box](#)" [▶ 77]

6 Application guidelines

In this chapter

6.1	Overview: Application guidelines	26
6.2	Setting up the domestic hot water tank	26
6.2.1	System layout – Standalone DHW tank	26
6.2.2	Selecting the volume and desired temperature for the DHW tank	27
6.2.3	Setup and configuration – DHW tank	28
6.2.4	DHW pump for instant hot water	28
6.2.5	DHW pump for disinfection	29
6.3	Setting up the energy metering	29
6.3.1	Produced heat	30
6.3.2	Consumed energy	30
6.3.3	Normal kWh rate power supply	30
6.4	Setting up the power consumption control	31
6.4.1	Permanent power limitation	31
6.4.2	Power limitation process	32

6.1 Overview: Application guidelines

The purpose of the application guidelines is to give a glance of the possibilities of the heat pump system.



NOTICE

- The illustrations in the application guidelines are meant for reference only, and are NOT to be used as detailed hydraulic diagrams. The detailed hydraulic dimensioning and balancing are NOT shown, and are the responsibility of the installer.
- For more information about the configuration settings to optimize heat pump operation, see "[10 Configuration](#)" [▶ 74].

This chapter contains application guidelines for:

- Setting up the domestic hot water tank
- Setting up the power consumption control

6.2 Setting up the domestic hot water tank

6.2.1 System layout – Standalone DHW tank

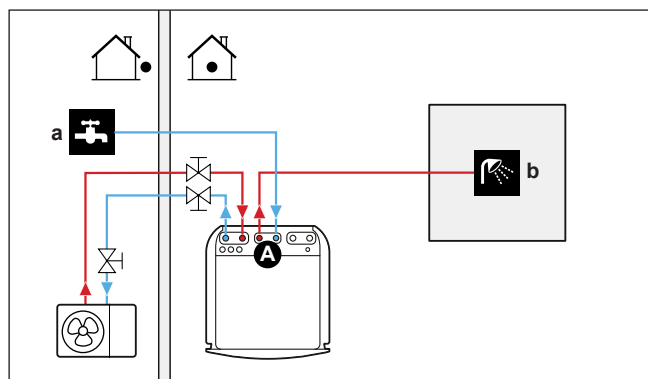

- A** Domestic hot water tank
- a** Cold water IN
- b** Hot water OUT

6.2.2 Selecting the volume and desired temperature for the DHW tank

People experience water as hot when its temperature is 40°C. Therefore, the DHW consumption is always expressed as equivalent hot water volume at 40°C. However, you can set the DHW tank temperature at a higher temperature (example: 53°C), which is then mixed with cold water (example: 15°C).

Selecting the volume and desired temperature for the DHW tank consists of:

- 1 Determining the DHW consumption (equivalent hot water volume at 40°C).
- 2 Determining the volume and desired temperature for the DHW tank.

Determining the DHW consumption

Answer the following questions and calculate the DHW consumption (equivalent hot water volume at 40°C) using typical water volumes:

Question	Typical water volume
How many showers are needed per day?	1 shower = 10 min × 10 l/min = 100 l
How many baths are needed per day?	1 bath = 150 l
How much water is needed at the kitchen sink per day?	1 sink = 2 min × 5 l/min = 10 l
Are there any other domestic hot water needs?	—

Example: If the DHW consumption of a family (4 persons) per day is as follows:

- 3 showers
- 1 bath
- 3 sink volumes

Then the DHW consumption = (3 × 100 l) + (1 × 150 l) + (3 × 10 l) = 480 l

Determining the volume and desired temperature for the DHW tank

Formula	Example
$V_1 = V_2 \times (T_2 - T_1) / (40 - T_1)$	If: <ul style="list-style-type: none"> ▪ $V_2 = 120$ l ▪ $T_2 = 54^\circ\text{C}$ ▪ $T_1 = 15^\circ\text{C}$ Then $V_1 = 187$ l
$V_2 = V_1 \times (40 - T_1) / (T_2 - T_1)$	If: <ul style="list-style-type: none"> ▪ $V_1 = 480$ l ▪ $T_2 = 54^\circ\text{C}$ ▪ $T_1 = 15^\circ\text{C}$ Then $V_2 = 307$ l

- V_1 DHW consumption (equivalent hot water volume at 40°C)
- V_2 Required DHW tank volume if only heated once
- T_2 DHW tank temperature
- T_1 Cold water temperature

Possible DHW tank volumes

Type	Possible volumes
Standalone DHW tank	<ul style="list-style-type: none"> ▪ 230 l

Energy saving tips

- If the DHW consumption differs from day to day, you can program a weekly schedule with different desired DHW tank temperatures for each day.
- The lower the desired DHW tank temperature, the more cost effective. By selecting a larger DHW tank, you can lower the desired DHW tank temperature.
- The heat pump itself can produce domestic hot water of maximum 53°C (or lower according to outdoor temperature). The electrical resistance integrated in the tank can increase this temperature. However, this consumes more energy. We recommend to set the desired DHW tank temperature below 53°C to minimize using the electrical resistance.
- In case multiple indoor units are connected to the outdoor unit: when the heat pump produces domestic hot water (DHW), depending on total demand for Air Conditioning (A/C) and the scheduled priority setting, it might not be able to do both DHW and A/C at the same time. In case you need DHW and A/C at the same, we recommend to produce the domestic hot water during the night when there is lower A/C demand or during the time when occupants are not present.

6.2.3 Setup and configuration – DHW tank

- For large DHW consumptions, you can heat up the DHW tank several times during the day.
- To heat up the DHW tank to the desired DHW tank temperature, you can use the following energy sources:
 - Thermodynamic cycle of the heat pump
 - Electrical backup heater
- For more information about:
 - Optimising the energy consumption for producing domestic hot water, see "[10 Configuration](#)" [▶ 74].
 - Connecting the water piping of the standalone DHW tank to the indoor unit, see the installation manual of the DHW tank.

6.2.4 DHW pump for instant hot water

Setup

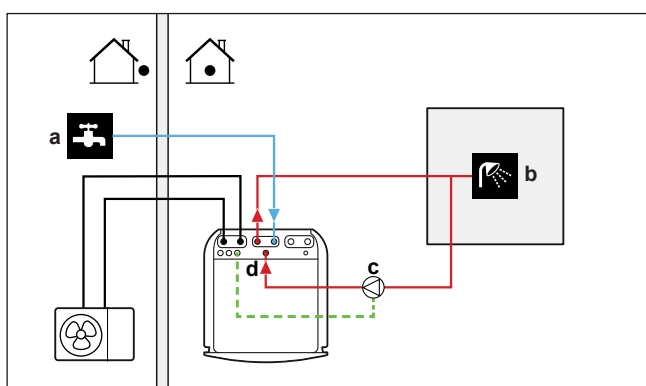

- a** Cold water IN
- b** Hot water OUT (shower (field supply))
- c** DHW pump (field supply)
- d** Recirculation connection

- By connecting a DHW pump, instant hot water can be available at the tap.
- The DHW pump and the installation are field supply and the responsibility of the installer. For the electrical wiring, see "[9.2.4 To connect the domestic hot water pump](#)" [▶ 72].

Configuration

- For more information, see "[10 Configuration](#)" [▶ 74].
- You can program a schedule to control the DHW pump via the user interface. For more information, see the user reference guide.

6.2.5 DHW pump for disinfection

Setup

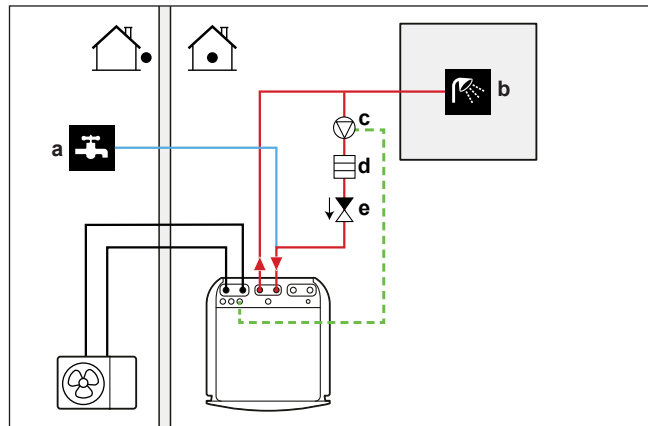

- a Cold water IN
- b Hot water OUT (shower (field supply))
- c DHW pump (field supply)
- d Heater element (field supply)
- e Non-return valve (field supply)

- The DHW pump is field-supplied and its installation is the responsibility of the installer. For the electrical wiring, see "[9.2.4 To connect the domestic hot water pump](#)" [▶ 72].
- If applicable legislation requires disinfection of the water piping until the tapping point, you can connect a DHW pump and heater element (if needed) as shown above.

Configuration

The indoor unit can control DHW pump operation. For more information, see "[10 Configuration](#)" [▶ 74].

6.3 Setting up the energy metering

- Via the user interface, you can read out the following energy data:
 - Produced heat
 - Consumed energy
- You can read out the energy data:
 - For domestic hot water production
- You can read out the energy data:
 - Per two hours (for the last 48 hours)
 - Per day (for the last 14 days)
 - Per month (for the last 24 months)
 - Total since installation



INFORMATION

The calculated produced heat and consumed energy are an estimation, the accuracy cannot be guaranteed.

6.3.1 Produced heat



INFORMATION

The sensors used to calculate the produced heat are calibrated automatically.

- The produced heat is calculated internally based on:
 - The leaving and entering water temperature
 - The flow rate
- Setup and configuration: No additional equipment needed.

6.3.2 Consumed energy

You can use the following methods to determine the consumed energy:

- Calculating

Calculating the consumed energy

- The consumed energy is calculated internally based on:
 - The actual power input of the outdoor unit
 - The set capacity of the backup heater
 - The voltage
- Setup and configuration: To get accurate energy data, measure the capacity (resistance measurement) and set the capacity via the user interface for the backup heater (step 1).

6.3.3 Normal kWh rate power supply

General rule

One power meter that covers the entire system is sufficient.

Setup

Connect the power meter to X5M/5 and X5M/6. See "[9.2.3 To connect the electricity meters](#)" [▶ 71].

Power meter type

In case of...	Use a... power meter
<ul style="list-style-type: none"> ▪ Single-phase outdoor unit ▪ Backup heater supplied from a single-phase grid, i.e. the backup heater model is: <ul style="list-style-type: none"> - *1.5 kW (1N~ 230 V) 	Single-phase

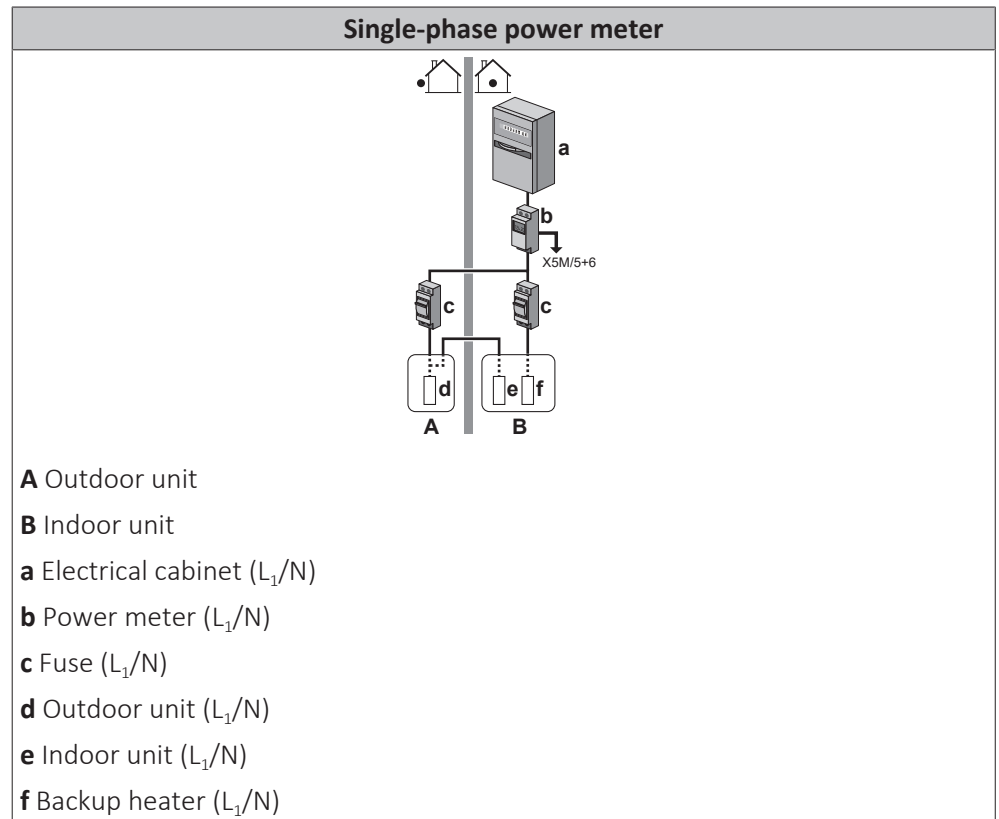
Example**Exception**

- You can use a second power meter if:
 - The power range of one meter is insufficient.
 - The electrical meter cannot easily be installed in the electrical cabinet.
 - 230 V and 400 V three-phase grids are combined (very uncommon), because of technical limitations of power meters.
- Connection and setup:
 - Connect the second power meter to X5M/3 and X5M/4. See "[9.2.3 To connect the electricity meters](#)" [▶ 71].
 - In the software the power consumption data of both meters is added so you do NOT have to set which meter covers which power consumption. You only need to set the number of pulses of each power meter.

6.4 Setting up the power consumption control

6.4.1 Permanent power limitation

Permanent power limitation is useful to assure a maximum power or current input of the system. In some countries, legislation limits the maximum power consumption for DHW production.

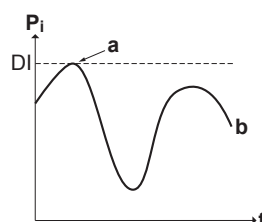

- P_i** Power input
- t** Time
- DI** Digital input (power limitation level)
- a** Power limitation active
- b** Actual power input

Setup and configuration

- No additional equipment needed.
- Set the power consumption control settings in [9.9] via the user interface (see "Power consumption control" [▶ 108]):
 - Select continuous limitation mode
 - Select the type of limitation (power in kW or current in A)
 - Set the desired power limitation level

6.4.2 Power limitation process

The outdoor unit has better efficiency than the electrical heater. Therefore, the electrical heater is limited and turned OFF first. The system limits power consumption in the following order:

- 1 Turns OFF the backup heater.
- 2 Limits the outdoor unit.
- 3 Turns OFF the outdoor unit.

Example

If the configuration is as follows: Power limitation level does NOT allow operation of backup heater (step 1).

Then power consumption is limited as follows:

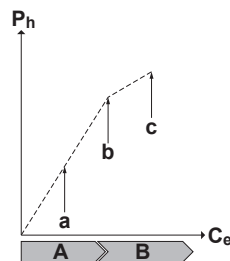

- P_h** Produced heat
- C_e** Consumed energy
- A** Outdoor unit
- B** Backup heater
- a** Limited outdoor unit operation
- b** Full outdoor unit operation
- c** Backup heater step 1 turned ON

7 Unit installation

In this chapter

7.1	Preparing the installation site	33
7.1.1	Installation site requirements of the indoor unit	33
7.1.2	Special requirements for R32 units	34
7.1.3	Installation patterns	36
7.2	Opening and closing the units	44
7.2.1	About opening the units	44
7.2.2	To open the indoor unit	44
7.2.3	To lower the switch box	46
7.2.4	To close the indoor unit	47
7.3	Mounting the indoor unit	47
7.3.1	About mounting the indoor unit	47
7.3.2	Precautions when mounting the indoor unit	47
7.3.3	To connect the drain hose to the drain	47
7.3.4	To install the indoor unit	48

7.1 Preparing the installation site



WARNING

The appliance shall be stored in a room without continuously operating ignition sources (example: open flames, an operating gas appliance or an operating electric heater).

Choose an installation location with sufficient space to transport the unit in and out of the site.

Do NOT install the unit in places often used as work place. In case of construction works (e.g. grinding works) where a lot of dust is created, the unit MUST be covered.



WARNING

DO NOT reuse refrigerant piping that has been used with any other refrigerant. Replace the refrigerant pipes or clean thoroughly.

7.1.1 Installation site requirements of the indoor unit

- The indoor unit is designed for indoor installation only and for the following ambient temperatures:
 - Domestic hot water production: 5~35°C
- Mind the following measurements guidelines:

Maximum refrigerant piping length ^(a) between indoor unit and outdoor unit	≤30 m
Minimum refrigerant piping length ^(a) between indoor unit and outdoor unit	3 m

^(a) Refrigerant piping length is the one-way length of liquid piping.

	Height difference outdoor-indoor	Height difference indoor-indoor
Outdoor unit installed higher than indoor unit	≤30 m	≤7.5 m

	Height difference outdoor-indoor	Height difference indoor-indoor
Outdoor unit installed lower than at least 1 indoor unit	≤15 m	≤15 m

- Mind the following spacing installation guidelines:

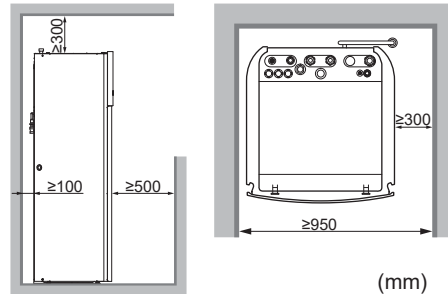

Additionally to the spacing guidelines: Because the total refrigerant charge in the system is ≥ 1.84 kg, the room where you install the indoor unit must also comply with the conditions described in "7.1.3 Installation patterns" [▶ 36].



INFORMATION

If you have limited installation space, do the following before installing the unit in its final position: "7.3.3 To connect the drain hose to the drain" [▶ 47]. It requires to remove one or both side panels.

- The foundation must be strong enough to bear the weight of the unit. Take the weight of the unit with a domestic hot water tank full of water into account. Make sure, in the event of a water leak, water cannot cause any damage to the installation space and surroundings.

Do NOT install the unit in places such as:

- In places where a mineral oil mist, spray or vapour may be present in the atmosphere. Plastic parts may deteriorate and fall off or cause water leakage.
- Sound sensitive areas (e.g. near a bedroom), so that the operation noise will cause no trouble.
- In places with high humidity (max. RH=85%), for example a bathroom.
- In places where frost is possible. Ambient temperature around the indoor unit must be $>5^{\circ}\text{C}$.

7.1.2 Special requirements for R32 units

Additionally to the spacing guidelines: Because the total refrigerant charge in the system is ≥ 1.84 kg, the room where you install the indoor unit must also comply with the conditions described in "7.1.3 Installation patterns" [▶ 36].



WARNING

- Do NOT pierce or burn refrigerant cycle parts.
- Do NOT use means to accelerate the defrosting process or to clean the equipment, other than those recommended by the manufacturer.
- Be aware that R32 refrigerant does NOT contain an odour.

**WARNING**

The appliance shall be stored so as to prevent mechanical damage and in a well-ventilated room without continuously operating ignition sources (example: open flames, an operating gas appliance or an operating electric heater) and have a room size as specified below.

**NOTICE**

- Do NOT re-use joints and copper gaskets which have been used already.
- Joints made in the installation between parts of the refrigerant system shall be accessible for maintenance purposes.

**WARNING**

Make sure installation, servicing, maintenance and repair comply with instructions from Daikin and with applicable legislation (for example national gas regulation) and are executed ONLY by authorised persons.

**NOTICE**

- The pipework shall be securely mounted and guarded protected from physical damage.
- Keep the pipework installation to a minimum.

7.1.3 Installation patterns



WARNING

For units using the R32 refrigerant it is necessary to keep any required ventilation openings and chimneys clear of obstructions.

Depending on the type of room in which you install the indoor unit, different installation patterns are allowed:

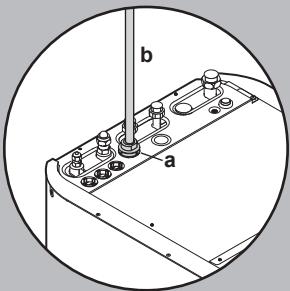
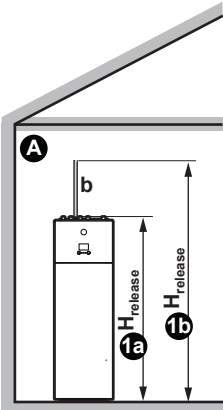
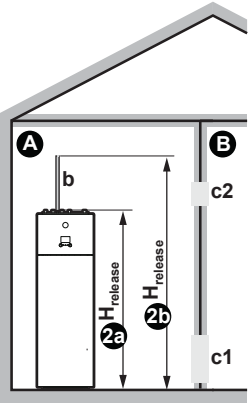
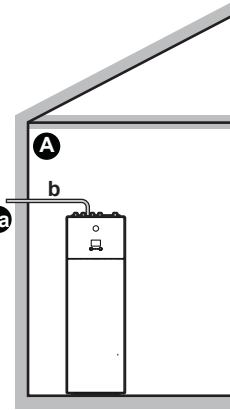
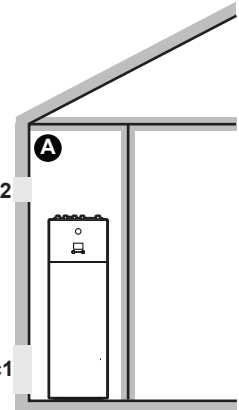
Room type	Allowed patterns			
Living room, kitchen, garage, attic, basement, storage room	1, 2, 3			
Technical room (i.e. room that is NEVER occupied by persons)	1, 2, 3, 4			
	PATTERN 1	PATTERN 2	PATTERN 3	PATTERN 4
				
Ventilation openings	N/A	Between room A and B	N/A	Between room A and outside
Minimum floor area	Room A	Room A + Room B	N/A	N/A
Chimney	Might be needed	Might be needed	Connected to outside	N/A
Release in case of refrigerant leakage	Inside room A	Inside room A	Outside	Inside room A
Restrictions	See "PATTERN 1" [▶ 38], "PATTERN 2" [▶ 38], "PATTERN 3" [▶ 40], and "Tables for PATTERN 1, 2 and 3" [▶ 40]			See "PATTERN 4" [▶ 43]

A	Room A (= room where indoor unit is installed)
B	Room B (= adjacent room)
a	If no chimney is installed, this is the default point of release in case of refrigerant leakage. If needed, you can connect a chimney here.
b	Chimney
c1	Bottom opening for natural ventilation
c2	Top opening for natural ventilation

H_{release}	<p>Actual release height:</p> <p>1b2a: Without chimney. From floor to top of the unit.</p> <ul style="list-style-type: none"> For 230 I units => $H_{\text{release}}=1.86$ m <p>1b2b: With chimney. From floor to top of the chimney.</p> <ul style="list-style-type: none"> For 230 I units => $H_{\text{release}}=1.86$ m + Chimney height
3a	Installation with chimney connected to the outside. The release height is not relevant. There are no requirements to the minimum floor area.
N/A	Not applicable

Minimum floor area / Release height:

- The minimum floor area requirements depend on the release height of the refrigerant in case of a leakage. The higher the release height, the lower the minimum floor area requirements.
- The default point of release (without chimney) is at the top of the unit. To decrease the minimum floor area requirements, you can increase the release height by installing a chimney. If the chimney leads outside of the building, there are no requirements anymore to the minimum floor area.
- You can also take advantage of the floor area of the adjacent room (= room B) by providing ventilation openings between the two rooms.
- For installations in technical rooms (i.e. room that is NEVER occupied by persons), additionally to patterns 1, 2 and 3, you can also use **PATTERN 4**. For this pattern there are no requirements to the minimum floor area if you provide 2 openings (one at the bottom, one at the top) between the room and the outside to ensure natural ventilation. The room must be protected from frost.



WARNING

Chimney connection. When connecting a chimney, take the following into account:

- Unit's connection point for the chimney = 1" male thread. Use a compatible counterpart for the chimney.
- Make sure the connection is airtight.
- The chimney material is unimportant.

PATTERN 1

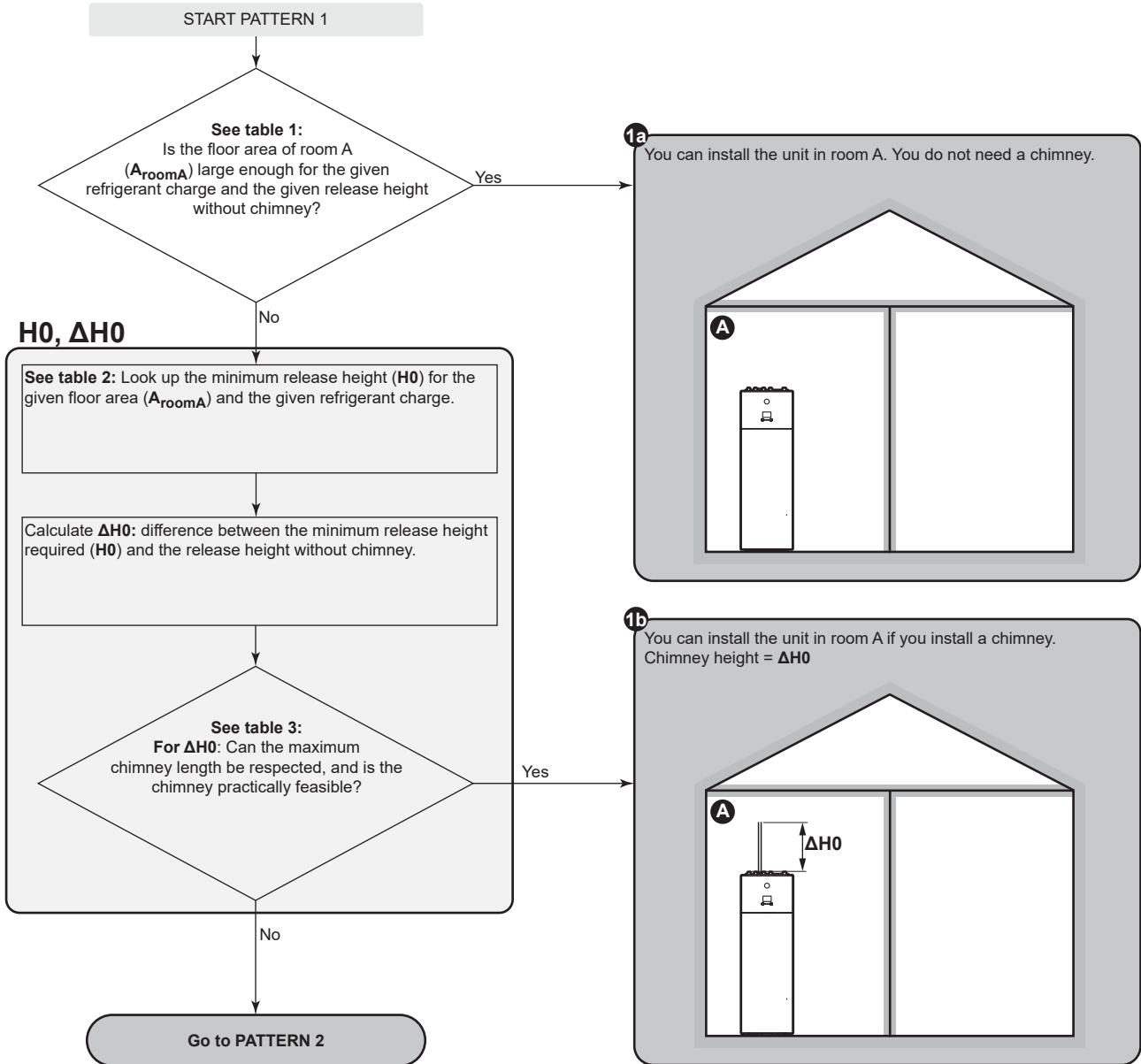

PATTERN 2

PATTERN 2: Conditions ventilation openings

If you want to take advantage of the floor area of the adjacent room, you must provide 2 openings (one at the bottom, one at the top) between the rooms to ensure natural ventilation. The openings must comply with the following conditions:

- **Bottom opening (A_{nv}):**
 - Must be a permanent opening that cannot be closed.
 - Must be completely located between 0 and 300 mm from the floor.
 - Must be $\geq A_{nv-min}$ (minimum bottom opening area).
 - $\geq 50\%$ of the required opening area A_{nv-min} must be ≤ 200 mm from the floor.
 - The bottom of the opening must be ≤ 100 mm from the floor.
 - If the opening starts from the floor, the height of the opening must be ≥ 20 mm.
- **Top opening:**
 - Must be a permanent opening that cannot be closed.
 - Must be $\geq 50\%$ of A_{nv-min} (minimum bottom opening area).
 - Must be ≥ 1.5 m from the floor.

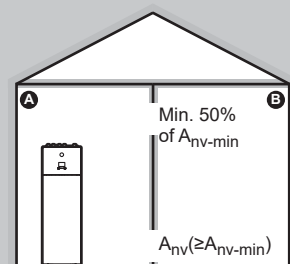

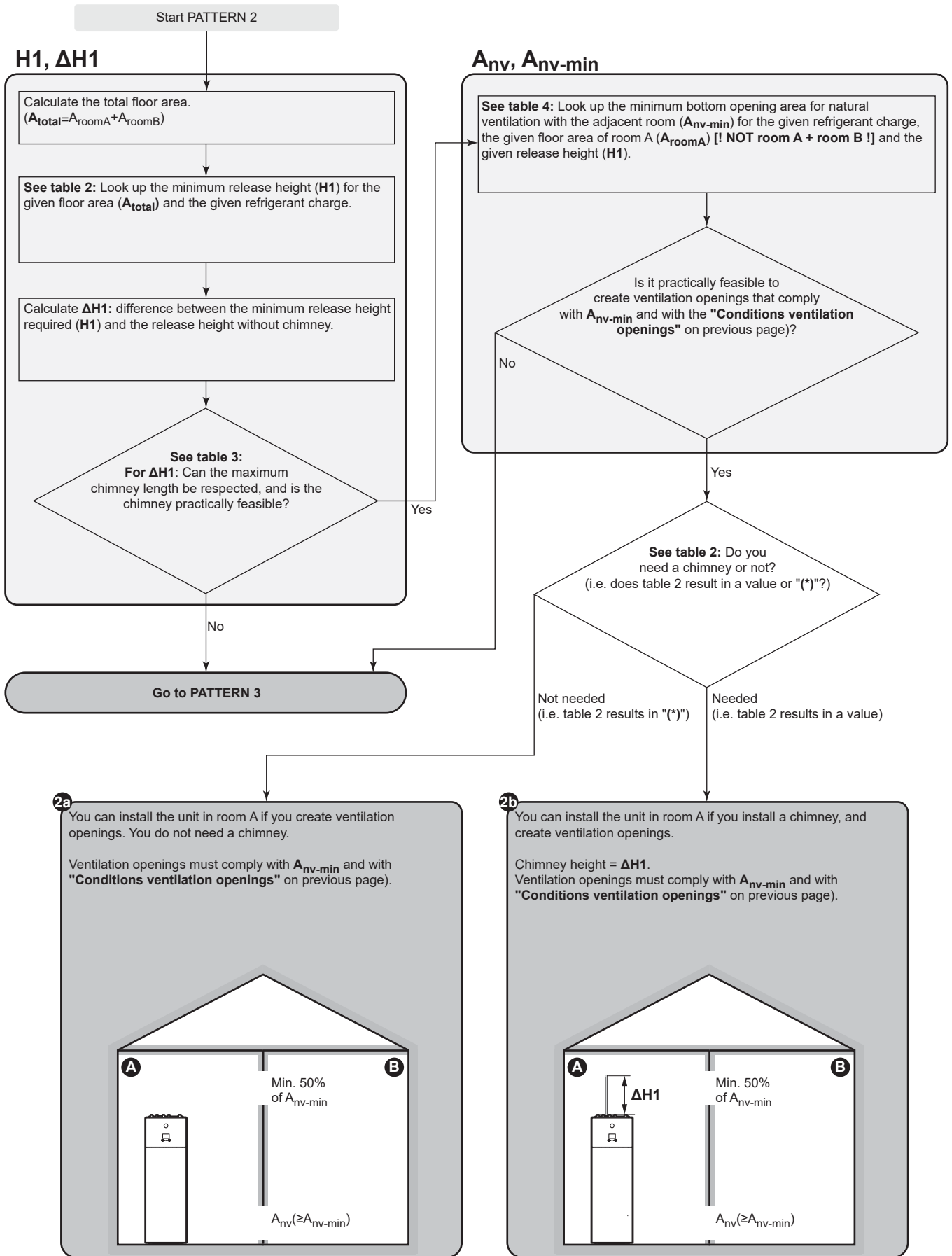

PATTERN 3

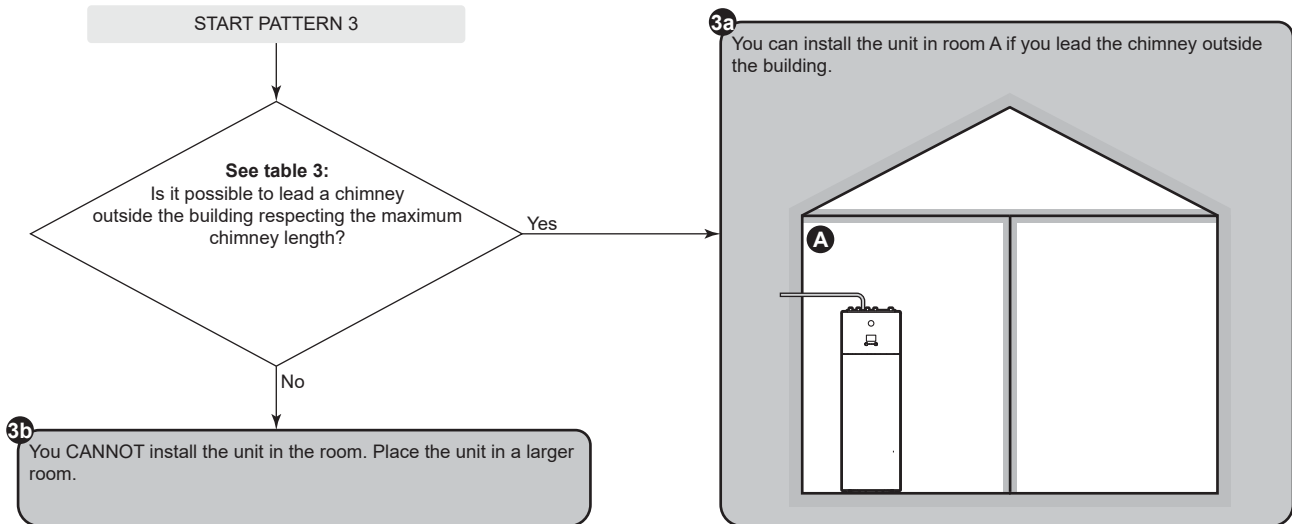

Tables for PATTERN 1, 2 and 3

Table 1: Minimum floor area

For intermediate refrigerant charges, use the row with the higher value. **Example:** If the refrigerant charge is 1.8 kg, use the row of 2 kg.

Minimum floor area (m ²)	
Charge (kg)	Release height without chimney (m)
	1.86 (Unit=230 l)
1.5	3.50
2	4.66
2.4	5.60
2.6	6.06
3	7.95
3.3	9.62

Table 2: Minimum release height

Take the following into account:

- For intermediate floor areas, use the column with the lower value. **Example:** If the floor area is 22.50 m², use the column of 20.00 m².
- For intermediate refrigerant charges, use the row with the higher value. **Example:** If the refrigerant charge is 1.8 kg, use the row of 2 kg.
- (*): The release height of the unit without chimney (for 230 l units: 1.86 m) is already higher than the minimum required release height. => OK (no chimney needed).

Minimum release height (m)							
Charge (kg)	Floor area (m ²)						
	2.50	5.00	10.00	15.00	20.00	25.00	30.00
1.5	2.61	(*)	(*)	(*)	(*)	(*)	(*)
2	3.47	1.74	(*)	(*)	(*)	(*)	(*)
2.4	4.17	2.08	(*)	(*)	(*)	(*)	(*)
2.6	4.52	2.26	(*)	(*)	(*)	(*)	(*)
3	5.21	2.61	1.66	(*)	(*)	(*)	(*)
3.3	5.73	2.87	1.83	(*)	(*)	(*)	(*)

Table 3: Maximum chimney length

When installing a chimney, the chimney length must be less than the maximum chimney length.

- Use the columns with the correct refrigerant charge. For intermediate refrigerant charges, use the columns with the higher value. **Example:** If the refrigerant charge is 3.0 kg, use the columns of 3.3 kg.
- For intermediate diameters, use the column with the lower value. **Example:** If the diameter is 23 mm, use the column of 22 mm.
- X: Not allowed

Maximum chimney length (m) – In case of Refrigerant charge=2.6 kg (and T=60°C)						In case of Refrigerant charge=3.3 kg (and T=60°C)				
Chimney	Inside diameter of chimney (mm)					Inside diameter of chimney (mm)				
	20 mm	22 mm	24 mm	26 mm	28 mm	20 mm	22 mm	24 mm	26 mm	28 mm
Straight pipe	46.99 m	78.61 m	123.42 m	185.02 m	267.54 m	27.35 m	46.93 m	74.81 m	113.26 m	164.87 m
1× 90° elbow	45.19 m	76.63 m	121.26 m	182.68 m	265.02 m	25.55 m	44.95 m	72.65 m	110.92 m	162.35 m
2× 90° elbow	43.39 m	74.65 m	119.10 m	180.34 m	262.50 m	23.75 m	42.97 m	70.49 m	108.58 m	159.83 m
3× 90° elbow	41.59 m	72.67 m	116.94 m	178.00 m	259.98 m	21.95 m	40.99 m	68.33 m	106.24 m	157.31 m

Table 4: Minimum bottom opening area for natural ventilation

Take the following into account:

- Use the correct table. For intermediate refrigerant charges, use the table with the higher value. **Example:** If the refrigerant charge is 1.8 kg, use the table of 2 kg.
- For intermediate floor areas, use the column with the lower value. **Example:** If the floor area is 12.50 m², use the column of 10.00 m².
- For intermediate release height values, use the row with the lower value. **Example:** If the release height is 1.90 m, use the row of 1.86 m.
- A_{nv}: Bottom opening area for natural ventilation.
- A_{nv-min}: Minimum bottom opening area for natural ventilation.
- (*): Already OK (no ventilation openings needed).

Minimum opening area for natural ventilation A _{nv} (m ²) - In case of Refrigerant charge=2.0 kg							
Release height (m)	Floor area of room A (m ²)						
	2.50	5.00	10.00	15.00	20.00	25.00	30.00
1.66	0.025	0.002	(*)	(*)	(*)	(*)	(*)
1.86	0.021	(*)	(*)	(*)	(*)	(*)	(*)
2.06	0.018	(*)	(*)	(*)	(*)	(*)	(*)
2.26	0.015	(*)	(*)	(*)	(*)	(*)	(*)
2.46	0.012	(*)	(*)	(*)	(*)	(*)	(*)
2.66	0.009	(*)	(*)	(*)	(*)	(*)	(*)
2.86	0.007	(*)	(*)	(*)	(*)	(*)	(*)
3.06	0.004	(*)	(*)	(*)	(*)	(*)	(*)

Minimum opening area for natural ventilation A _{nv} (m ²) - In case of Refrigerant charge=2.4 kg							
Release height (m)	Floor area of room A (m ²)						
	2.50	5.00	10.00	15.00	20.00	25.00	30.00
1.66	0.035	0.012	(*)	(*)	(*)	(*)	(*)
1.86	0.031	0.006	(*)	(*)	(*)	(*)	(*)
2.06	0.027	0.001	(*)	(*)	(*)	(*)	(*)
2.26	0.023	(*)	(*)	(*)	(*)	(*)	(*)
2.46	0.020	(*)	(*)	(*)	(*)	(*)	(*)
2.66	0.017	(*)	(*)	(*)	(*)	(*)	(*)
2.86	0.014	(*)	(*)	(*)	(*)	(*)	(*)
3.06	0.011	(*)	(*)	(*)	(*)	(*)	(*)

Minimum opening area for natural ventilation A _{nv} (m ²) - In case of Refrigerant charge=2.6 kg							
Release height (m)	Floor area of room A (m ²)						
	2.50	5.00	10.00	15.00	20.00	25.00	30.00
1.66	0.040	0.017	(*)	(*)	(*)	(*)	(*)
1.86	0.035	0.011	(*)	(*)	(*)	(*)	(*)

Minimum opening area for natural ventilation A_{nv} (m ²) - In case of Refrigerant charge=2.6 kg							
Release height (m)	Floor area of room A (m ²)						
	2.50	5.00	10.00	15.00	20.00	25.00	30.00
2.06	0.031	0.005	(*)	(*)	(*)	(*)	(*)
2.26	0.027	(*)	(*)	(*)	(*)	(*)	(*)
2.46	0.024	(*)	(*)	(*)	(*)	(*)	(*)
2.66	0.021	(*)	(*)	(*)	(*)	(*)	(*)
2.86	0.018	(*)	(*)	(*)	(*)	(*)	(*)
3.06	0.015	(*)	(*)	(*)	(*)	(*)	(*)

Minimum opening area for natural ventilation A_{nv} (m ²) - In case of Refrigerant charge=3.3 kg							
Release height (m)	Floor area of room A (m ²)						
	2.50	5.00	10.00	15.00	20.00	25.00	30.00
1.66	0.057	0.034	0.008	(*)	(*)	(*)	(*)
1.86	0.051	0.027	(*)	(*)	(*)	(*)	(*)
2.06	0.046	0.020	(*)	(*)	(*)	(*)	(*)
2.26	0.042	0.015	(*)	(*)	(*)	(*)	(*)
2.46	0.038	0.009	(*)	(*)	(*)	(*)	(*)
2.66	0.034	0.005	(*)	(*)	(*)	(*)	(*)
2.86	0.031	(*)	(*)	(*)	(*)	(*)	(*)
3.06	0.028	(*)	(*)	(*)	(*)	(*)	(*)

PATTERN 4

PATTERN 4 is only allowed for installations in technical rooms (i.e. room that is NEVER occupied by persons). For this pattern there are no requirements to the minimum floor area if you provide 2 openings (one at the bottom, one at the top) between the room and the outside to ensure natural ventilation. The room must be protected from frost.

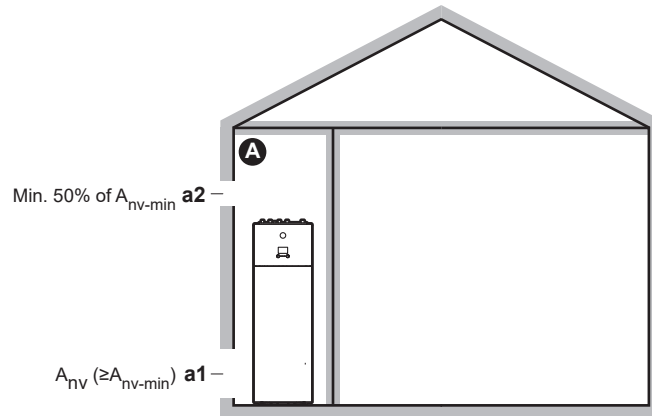

A	Unoccupied room where the indoor unit is installed. Must be protected from frost.
a1	<p>A_{nv}: Bottom opening for natural ventilation between the unoccupied room and the outside.</p> <ul style="list-style-type: none"> Must be a permanent opening that cannot be closed. Must be above ground level. Must be completely located between 0 and 300 mm from the floor of the unoccupied room. Must be $\geq A_{nv-min}$ (minimum bottom opening area as specified in the table below). $\geq 50\%$ of the required opening area A_{nv-min} must be ≤ 200 mm from the floor of the unoccupied room. The bottom of the opening must be ≤ 100 mm from the floor of the unoccupied room. If the opening starts from the floor, the height of the opening must be ≥ 20 mm.
a2	<p>Top opening for natural ventilation between room A and the outside.</p> <ul style="list-style-type: none"> Must be a permanent opening that cannot be closed. Must be $\geq 50\%$ of A_{nv-min} (minimum bottom opening area as specified in the table below). Must be ≥ 1.5 m from the floor of the unoccupied room.

A_{nv-min} (minimum bottom opening area for natural ventilation)

The minimum bottom opening area for natural ventilation between the unoccupied room and the outside depends on the total refrigerant in the system. For intermediate refrigerant charges, use the row with the higher value. **Example:** If the refrigerant charge is 1.8 kg, use the row of 2 kg.

Total refrigerant charge (kg)	A_{nv-min} (dm ²)
1.5 kg	6.2 dm ²
2 kg	7.1 dm ²
2.4 kg	7.8 dm ²

Total refrigerant charge (kg)	A _{nv-min} (dm ²)
2.6 kg	8.1 dm ²
3 kg	8.8 dm ²
3.3 kg	9.2 dm ²

7.2 Opening and closing the units

7.2.1 About opening the units

At certain times, you have to open the unit. **Example:**

- When connecting the electrical wiring
- When maintaining or servicing the unit



DANGER: RISK OF ELECTROCUTION

Do NOT leave the unit unattended when the service cover is removed.

7.2.2 To open the indoor unit

Overview

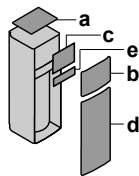

- a** Top panel
- b** User interface panel
- c** Switch box cover
- d** Front panel
- e** High voltage switch box cover

Open

- 1 Remove the top panel

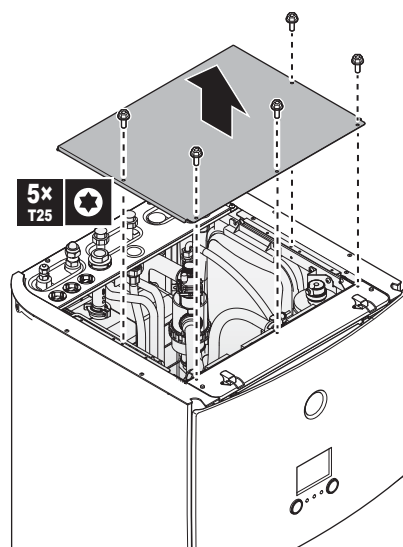

- 2 Remove the user interface panel. Open the hinges at the top and slide the top panel upwards.

**NOTICE**

If you remove the user interface panel, also disconnect the cables from the back of the user interface panel to prevent damage.

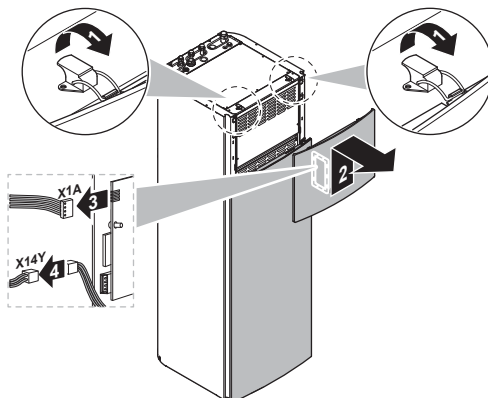

- 3** Remove the switch box cover.

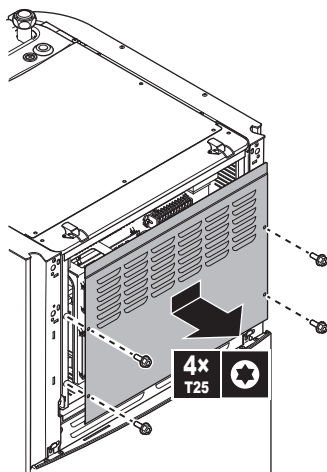

- 4** If necessary, remove the front plate. This is, for example, necessary in the following cases:
- "7.2.3 To lower the switch box" [▶ 46]
 - "7.3.3 To connect the drain hose to the drain" [▶ 47]
 - When you need access to the high voltage switch box

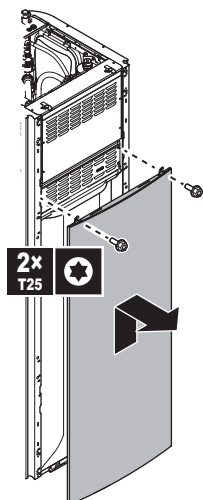

- 5** If you need access to the high voltage components, remove the high voltage switch box cover.

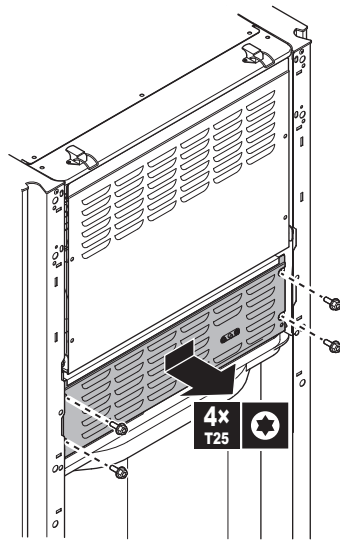

7.2.3 To lower the switch box

During the installation, you will need access to the inside of the indoor unit. To have easier front access, hang the switch box outside the unit, over the high voltage switch box cover.

Prerequisite: The user interface panel and front panel have been removed.

- 1 Remove the fixing plate at the top of the unit.
- 2 Tilt the switch box to the front and lift it out of its hinges.

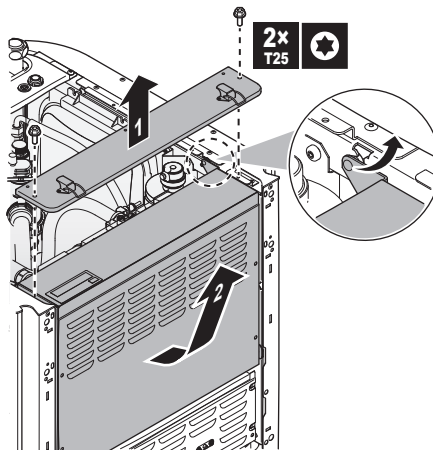

- 3 Hang the switch box in front of the high voltage switch box cover. Use the 2 hinges located lower on the unit.

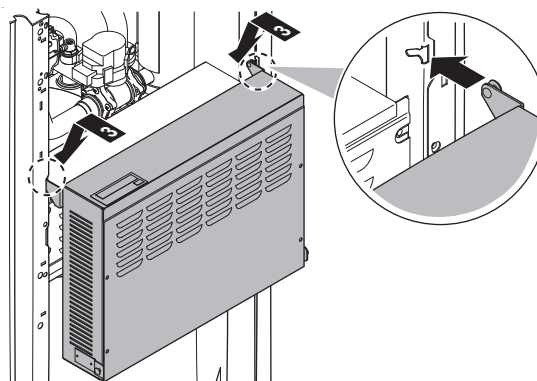

7.2.4 To close the indoor unit

- 1 Close the cover of the switch box.
- 2 Put the switch box back into place.
- 3 Reinstall the top panel.
- 4 Reinstall the side panels.
- 5 Reinstall the front panel.
- 6 Reconnect the cables to the user interface panel.
- 7 Reinstall the user interface panel.



NOTICE

When closing the indoor unit, make sure that the tightening torque does NOT exceed 4.1 N•m.

7.3 Mounting the indoor unit

7.3.1 About mounting the indoor unit

When

You have to mount the outdoor and indoor unit before you can connect the refrigerant and water piping.

Typical workflow

Mounting the indoor unit typically consists of the following stages:

- 1 Installing the indoor unit.
- 2 Connecting the drain hose to the drain.

7.3.2 Precautions when mounting the indoor unit



INFORMATION

Also read the precautions and requirements in the following chapters:

- ["2 General safety precautions" \[9\]](#)
- ["7.1 Preparing the installation site" \[33\]](#)

7.3.3 To connect the drain hose to the drain

Water coming from the pressure relief valve is collected in the drain pan. The drain pan is connected to a drain hose inside the unit. Connect the drain hose to an appropriate drain according to the applicable legislation. You can route the drain hose through the left or right side panel.

Prerequisite: The user interface panel and front panel have been removed.

- 1 Remove one of the side panels.
- 2 Cut out the rubber grommet.
- 3 Pull the drain hose through the hole.
- 4 Reattach the side panel. Ensure the water can flow through the drain tube.

It is recommended to use a tundish to collect the water.

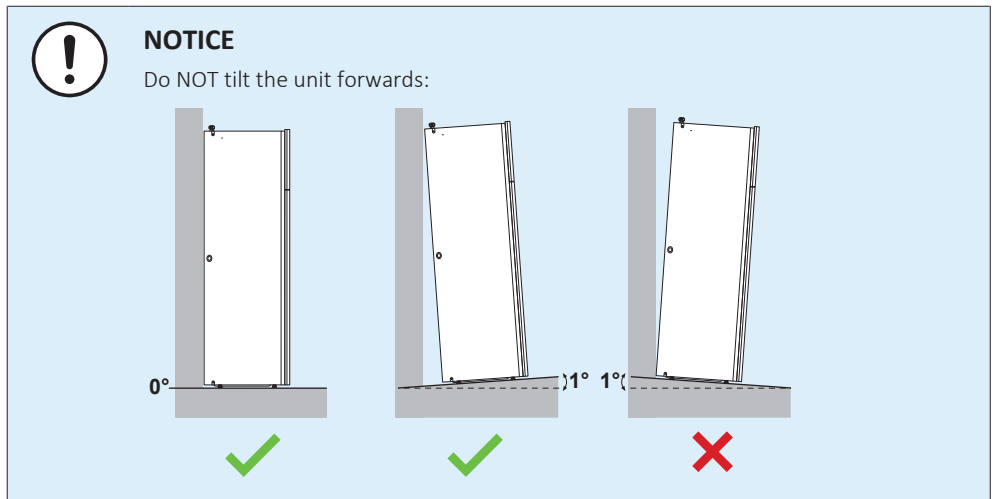

8 Piping installation

In this chapter

8.1	Preparing refrigerant piping	50
8.1.1	Refrigerant piping requirements	50
8.1.2	Refrigerant piping insulation for the indoor unit	51
8.2	Connecting the refrigerant piping	51
8.2.1	About connecting the refrigerant piping	51
8.2.2	Precautions when connecting the refrigerant piping	52
8.2.3	To connect the refrigerant piping to the indoor unit	52
8.3	Checking the refrigerant piping	53
8.3.1	About checking the refrigerant piping	53
8.3.2	Precautions when checking the refrigerant piping	53
8.3.3	Checking refrigerant piping: Setup	54
8.3.4	To check for leaks	54
8.3.5	To perform vacuum drying	54
8.4	Charging refrigerant	55
8.5	Preparing water piping	55
8.5.1	To check the flow rate	56
8.5.2	Water circuit requirements	56
8.5.3	Formula to calculate the expansion vessel pre-pressure	59
8.5.4	Changing the pre-pressure of the expansion vessel	59
8.6	Connecting water piping	59
8.6.1	About connecting the water piping	59
8.6.2	Precautions when connecting the water piping	60
8.6.3	To connect the water piping	60
8.6.4	To connect the water piping for domestic hot water	61
8.6.5	To connect the recirculation piping	64
8.6.6	To fill the heating circuit for domestic hot water	64
8.6.7	To fill the domestic hot water tank	65
8.6.8	To insulate the water piping	65

8.1 Preparing refrigerant piping

8.1.1 Refrigerant piping requirements



INFORMATION

Also read the precautions and requirements in the "2 General safety precautions" [▶ 9].

Also see "7.1.2 Special requirements for R32 units" [▶ 34] for additional requirements.

- **Piping length:** See "7.1.1 Installation site requirements of the indoor unit" [▶ 33].

Piping material

Phosphoric acid deoxidised seamless copper

- **Piping connections:** Only flare and brazed connections are allowed. The indoor and outdoor units have flare connections. Connect both ends without brazing. If brazing should be needed, take the guidelines in the installer reference guide into account.

Flare connections

Only use annealed material.

- **Piping diameter for the indoor unit:**

Liquid piping	Gas piping
Ø6.35 mm (1/4")	Ø15.9 mm (5/8")

Piping temper grade and thickness for the indoor unit

Outer diameter (ϕ)	Tempter grade	Thickness (t) ^(a)	
6.5 mm (1/4")	Annealed (O)	≥0.8 mm	
15.9 mm (5/8")	Annealed (O)	≥1.0 mm	

^(a) Depending on the applicable legislation and the maximum working pressure of the unit (see "PS High" on the unit name plate), larger piping thickness might be required.

8.1.2 Refrigerant piping insulation for the indoor unit

- Use polyethylene foam as insulation material:
 - with a heat transfer rate between 0.041 and 0.052 W/mK (0.035 and 0.045 kcal/mh°C)
 - with a heat resistance of at least 120°C
- Insulation thickness:

Pipe outer diameter (ϕ_p)	Insulation inner diameter (ϕ_i)	Insulation thickness (t)
6.35 mm (1/4")	7~10 mm	≥13 mm
15.9 mm (5/8")	17~20 mm	≥13 mm

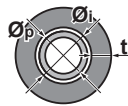

If the temperature is higher than 30°C and the humidity is higher than RH 80%, the thickness of the insulation materials should be at least 20 mm to prevent condensation on the surface of the insulation.

**INFORMATION**

Refer to the installer reference guide of the outdoor unit for more information.

8.2 Connecting the refrigerant piping

**NOTICE**

Vibration. To prevent vibration of the refrigerant piping during operation, fixate the piping between the outdoor and indoor unit.

8.2.1 About connecting the refrigerant piping

Before connecting the refrigerant piping

Make sure the outdoor and indoor unit are mounted.

Typical workflow

Connecting the refrigerant piping involves:

- Connecting the refrigerant piping to the outdoor unit
- Connecting the refrigerant piping to the indoor unit
- Insulating the refrigerant piping

- Keeping in mind the guidelines for:
 - Pipe bending
 - Flaring pipe ends
 - Brazing
 - Using the stop valves

8.2.2 Precautions when connecting the refrigerant piping

 **DANGER: RISK OF BURNING/SCALDING**

 **NOTICE**

- Do NOT use mineral oil on flared part.
- Do NOT reuse piping from previous installations.
- NEVER install a drier to this R32 unit to guarantee its lifetime. The drying material may dissolve and damage the system.

 **NOTICE**

Take the following precautions on refrigerant piping into account:

- Avoid anything but the designated refrigerant to get mixed into the refrigerant cycle (e.g. air).
- Only use R32 when adding refrigerant.
- Only use installation tools (e.g. manifold gauge set) that are exclusively used for R32 installations to withstand the pressure and to prevent foreign materials (e.g. mineral oils and moisture) from mixing into the system.
- Install the piping so that the flare is NOT subjected to mechanical stress.
- Do NOT leave pipes unattended at the site. If the installation is NOT done within 1 day, protect the piping as described in the following table to prevent dirt, liquid or dust from entering the piping.
- Use caution when passing copper tubes through walls (see figure below).

Unit	Installation period	Protection method
Outdoor unit	>1 month	Pinch the pipe
	<1 month	Pinch or tape the pipe
Indoor unit	Regardless of the period	

 **INFORMATION**

Refer to the installer reference guide of the outdoor unit for more information.

 **NOTICE**

Do NOT open the refrigerant stop valve before checking the refrigerant piping. When you need to charge additional refrigerant it is recommended to open the refrigerant stop valve after charging.

8.2.3 To connect the refrigerant piping to the indoor unit

- 1 Connect the liquid stop valve from the outdoor unit to the refrigerant liquid connection of the indoor unit.

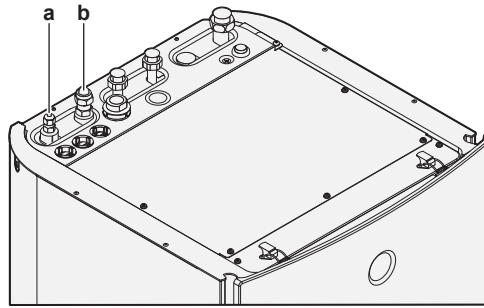

- a** Refrigerant liquid connection
b Refrigerant gas connection

- 2 Connect the gas stop valve from the outdoor unit to the refrigerant gas connection of the indoor unit.

8.3 Checking the refrigerant piping

8.3.1 About checking the refrigerant piping

The outdoor unit's **internal** refrigerant piping has been factory tested for leaks. You only have to check the outdoor unit's **external** refrigerant piping.

Before checking the refrigerant piping

Make sure the refrigerant piping is connected between the outdoor unit and the indoor unit.

Typical workflow

Checking the refrigerant piping typically consists of the following stages:

- 1 Checking for leaks in the refrigerant piping.
- 2 Performing vacuum drying to remove all moisture, air or nitrogen from the refrigerant piping.

If there is a possibility of moisture being present in the refrigerant piping (for example, water may have entered the piping), first carry out the vacuum drying procedure below until all moisture has been removed.

8.3.2 Precautions when checking the refrigerant piping



NOTICE

Use a 2-stage vacuum pump with a non-return valve that can evacuate to a gauge pressure of -100.7 kPa (-1.007 bar)(5 Torr absolute). Make sure the pump oil does not flow oppositely into the system while the pump is not working.



NOTICE

Use this vacuum pump for R32 exclusively. Using the same pump for other refrigerants may damage the pump and the unit.



NOTICE

- Connect the vacuum pump to **both** the service port of the gas stop valve and the service port of the liquid stop valve to increase efficiency.
- Make sure that the gas stop valve and liquid stop valve are firmly closed before performing the leak test or vacuum drying.

8.3.3 Checking refrigerant piping: Setup

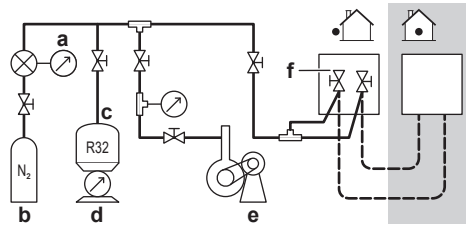

- a Pressure gauge
- b Nitrogen
- c Refrigerant
- d Weighing scale
- e Vacuum pump
- f Stop valve

8.3.4 To check for leaks



NOTICE

Do NOT exceed the unit's maximum working pressure (see "PS High" on the unit name plate).



NOTICE

ALWAYS use a recommended bubble test solution from your wholesaler.

NEVER use soap water:

- Soap water may cause cracking of components, such as flare nuts or stop valve caps.
- Soap water may contain salt, which absorbs moisture that will freeze when the piping gets cold.
- Soap water contains ammonia which may lead to corrosion of flared joints (between the brass flare nut and the copper flare).

- 1 Charge the system with nitrogen gas up to a gauge pressure of at least 200 kPa (2 bar). It is recommended to pressurize to 3000 kPa (30 bar) or higher (depending on local legislation) to detect small leaks.
- 2 Check for leaks by applying the bubble test solution to all connections.
- 3 Discharge all nitrogen gas.

8.3.5 To perform vacuum drying



NOTICE

- Connect the vacuum pump to **both** the service port of the gas stop valve and the service port of the liquid stop valve to increase efficiency.
- Make sure that the gas stop valve and liquid stop valve are firmly closed before performing the leak test or vacuum drying.

- 1 Vacuum the system until the pressure on the manifold indicates -0.1 MPa (-1 bar).
- 2 Leave as is for 4-5 minutes and check the pressure:

If the pressure...	Then...
Does not change	There is no moisture in the system. This procedure is finished.
Increases	There is moisture in the system. Go to the next step.

- 3 Vacuum the system for at least 2 hours to a manifold pressure of -0.1 MPa (-1 bar).
- 4 After turning the pump OFF, check the pressure for at least 1 hour.
- 5 If you do NOT reach the target vacuum or CANNOT maintain the vacuum for 1 hour, do the following:
 - Check for leaks again.
 - Perform vacuum drying again.

**NOTICE**

Make sure to open the stop valves after installing the refrigerant piping and performing vacuum drying. Running the system with the stop valves closed may break the compressor.

**INFORMATION**

After opening the stop valve, it is possible that the pressure in the refrigerant piping does NOT increase. This might be caused by e.g. the closed state of the expansion valve in the outdoor unit circuit, but does NOT present any problem for correct operation of the unit.

8.4 Charging refrigerant

**INFORMATION**

Refer to the installer reference guide of the outdoor unit for more information.

8.5 Preparing water piping

**NOTICE**

In case of plastic pipes, make sure they are fully oxygen diffusion tight according to DIN 4726. The diffusion of oxygen into the piping can lead to excessive corrosion.

**NOTICE**

Water circuit requirements. Make sure to comply with the water pressure and water temperature requirements below. For additional water circuit requirements, see the installer reference guide.

- **Water pressure – Domestic hot water.** The maximum water pressure is 10 bar ($=1.0$ MPa), and must be in accordance with the applicable legislation. Provide adequate safeguards in the water circuit to ensure that the maximum pressure is NOT exceeded (see "[8.6.3 To connect the water piping](#)" [▶ 60]). The minimum water pressure to operate is 1 bar ($=0.1$ MPa).
- **Water pressure – Heating circuit for domestic hot water.** The maximum water pressure is 3 bar ($=0.3$ MPa). Ensure that the maximum pressure is NOT exceeded. The minimum water pressure to operate is 1 bar ($=0.1$ MPa).
- **Water temperature.** All installed piping and piping accessories (valve, connections,...) MUST withstand the following temperatures:

**INFORMATION**

The following figure is an example and may NOT completely match your system layout.

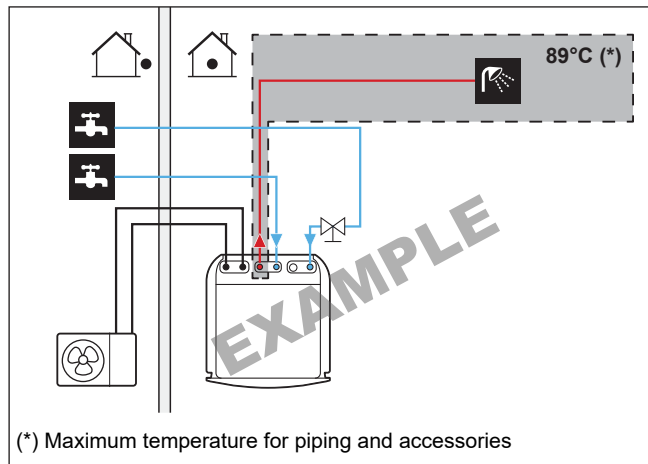

8.5.1 To check the flow rate

Minimum flow rate

Check that the minimum flow rate in the domestic hot water is guaranteed in all conditions.

If operation is...	Then the minimum required flow rate is...
Domestic hot water production/defrost	22 l/min



NOTICE

It is important to ALWAYS guarantee the minimum flow rate. In case the minimum flow rate cannot be reached, a flow error 7H will be generated (no domestic hot water heating or operation). The tank has a fixed volume. Ensure that the water circuit of the tank is filled and verify that the minimum water pressure of 1 bar is maintained.

See the recommended procedure as described in "11.4 Checklist during commissioning" [▶ 119].

8.5.2 Water circuit requirements



INFORMATION

Also read the precautions and requirements in the "2 General safety precautions" [▶ 9].



NOTICE

In case of plastic pipes, make sure they are fully oxygen diffusion tight according to DIN 4726. The diffusion of oxygen into the piping can lead to excessive corrosion.

- **Connecting piping – Legislation.** Make all piping connections in accordance with the applicable legislation and the instructions in the "Installation" chapter, respecting the water inlet and outlet.
- **Connecting piping – Force.** Do NOT use excessive force when connecting the piping. Deformation of the piping can cause malfunctioning of the unit.
- **Connecting piping – Tools.** Only use appropriate tooling to handle brass, which is a soft material. If NOT, pipes will get damaged.

- **Connecting piping – Air, moisture, dust.** If air, moisture or dust gets into the circuit, problems may occur. To prevent this:
 - ONLY use clean pipes.
 - Hold the pipe end downwards when removing burrs.
 - Cover the pipe end when inserting it through a wall, to prevent dust and/or particles from entering the pipe.
 - Use a decent thread sealant to seal connections.
 - When using non-brass metallic piping, make sure to insulate both materials from each other to prevent galvanic corrosion.
 - Because brass is a soft material, use appropriate tooling for connecting the water circuit. Inappropriate tooling will cause damage to the pipes.
- **Glycol.** For safety reasons, it is NOT allowed to add any kind of glycol to the water circuit.
- **Piping length.** It is recommended to avoid long runs of piping between the domestic hot water tank and the hot water end point (shower, bath,...) and to avoid dead ends.
- **Piping diameter.** Select the water piping diameter in relation to the required water flow and the available external static pressure of the pump. See "[16 Technical data](#)" [▶ 140] for the external static pressure curves of the indoor unit.
- **Water flow.** You can find the minimum required water flow for indoor unit operation in the following table. In all cases, this flow needs to be guaranteed. When the flow is lower, the indoor unit will stop operation and display error 7H.

If operation is...	Then the minimum required flow rate is...
Domestic hot water production/defrost	22 l/min

- **Field supply components – Water.** Only use materials that are compatible with water used in the system and with the materials used in the indoor unit.
- **Field supply components – Water pressure and temperature.** Check that all components in the field piping can withstand the water pressure and water temperature.
- **Water pressure – Domestic hot water.** The maximum water pressure is 10 bar (=1.0 MPa), and must be in accordance with the applicable legislation. Provide adequate safeguards in the water circuit to ensure that the maximum pressure is NOT exceeded (see "[8.6.3 To connect the water piping](#)" [▶ 60]). The minimum water pressure to operate is 1 bar (=0.1 MPa).
- **Water pressure – Heating circuit for domestic hot water.** The maximum water pressure is 3 bar (=0.3 MPa). Ensure that the maximum pressure is NOT exceeded. The minimum water pressure to operate is 1 bar (=0.1 MPa).
- **Water temperature.** All installed piping and piping accessories (valve, connections,...) MUST withstand the following temperatures:



INFORMATION

The following figure is an example and may NOT completely match your system layout.

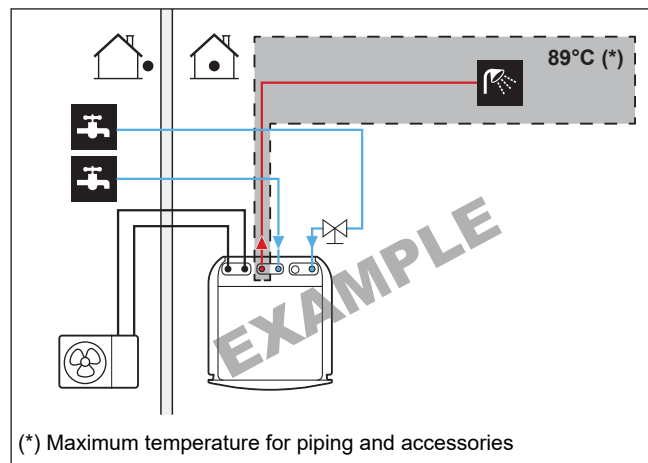

- **Drainage – Low points.** Provide drain taps at all low points of the system in order to allow complete drainage of the water circuit.
- **Drainage – Pressure relief valve.** Connect the drain hose properly to the drain to avoid water dripping out of the unit. See "[7.3.3 To connect the drain hose to the drain](#)" [▶ 47].
- **Air vents.** Provide air vents at all high points of the system, which must also be easily accessible for servicing. Two automatic air purges are provided in the indoor unit. Check that the air purges are NOT tightened too much, so that automatic release of air in the water circuit is possible.
- **Zn-coated parts.** NEVER use zinc coated parts in the water circuit. Because the internal water circuit of the unit uses copper piping, excessive corrosion may occur.
- **Non-brass metallic piping.** When using non-brass metallic piping, insulate the brass and non-brass properly so that they do NOT make contact with each other. This to prevent galvanic corrosion.
- **Domestic hot water tank – Capacity.** To avoid stagnation of water, it is important that the storage capacity of the domestic hot water tank meets the daily consumption of domestic hot water.
- **Domestic hot water tank – After installation.** Immediately after installation, the domestic hot water tank must be flushed with fresh water. This procedure must be repeated at least once a day the first 5 consecutive days after installation.
- **Domestic hot water tank – Standstills.** In cases where during longer periods of time there is no consumption of hot water, the equipment MUST be flushed with fresh water before usage.
- **Domestic hot water tank – Disinfection.** For the disinfection function of the domestic hot water tank, see "[10.6.2 Tank](#)" [▶ 92] and "[6.2.5 DHW pump for disinfection](#)" [▶ 29].
- **Thermostatic mixing valves.** In accordance with the applicable legislation, it may be necessary to install thermostatic mixing valves.
- **Hygienic measures.** The installation must be in compliance with the applicable legislation and may require additional hygienic installation measures.
- **Recirculation pump.** In accordance with the applicable legislation, it may be required to connect a recirculation pump in between the hot water end point and the recirculation connection of the domestic hot water tank.

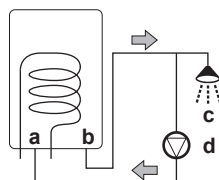

- a Recirculation connection
- b Hot water connection
- c Shower
- d Recirculation pump

8.5.3 Formula to calculate the expansion vessel pre-pressure

The pre-pressure (P_g) of the vessel depends on the installation height difference (H):

$$P_g = 0.3 + (H/10) \text{ (bar)}$$

8.5.4 Changing the pre-pressure of the expansion vessel



NOTICE

ONLY a licensed installer may adjust the pre-pressure of the expansion vessel.

The default pre-pressure of the expansion vessel is 1 bar. When it is required to change the pre-pressure, take following guidelines into account:

- Only use dry nitrogen to set the expansion vessel pre-pressure.
- Inappropriate setting of the expansion vessel pre-pressure will lead to malfunction of the system.

Changing the pre-pressure of the expansion vessel should be done by releasing or increasing nitrogen pressure through the Schrader valve of the expansion vessel.

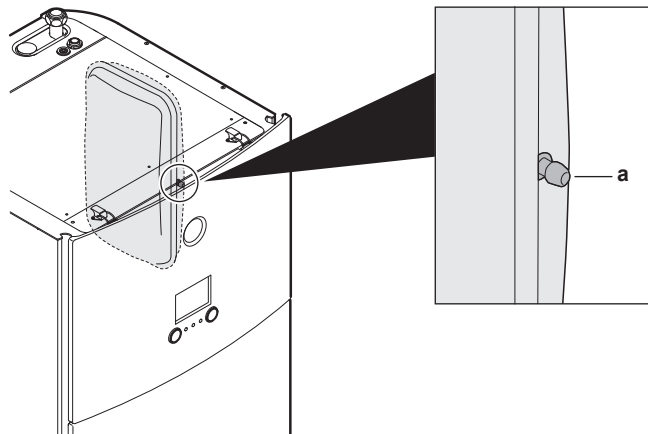

a Schrader valve

8.6 Connecting water piping

8.6.1 About connecting the water piping

Before connecting the water piping

Make sure the outdoor and indoor unit are mounted.

Typical workflow

Connecting the water piping typically consists of the following stages:

- 1 Connecting the water piping to the indoor unit.
- 2 Connecting the recirculation piping.
- 3 Connecting the drain hose to the drain.
- 4 Filling the water circuit.
- 5 Filling the domestic hot water tank.
- 6 Insulating the water piping.

8.6.2 Precautions when connecting the water piping



INFORMATION

Also read the precautions and requirements in the following chapters:

- "2 General safety precautions" [▶ 9]
- "8.5 Preparing water piping" [▶ 55]

8.6.3 To connect the water piping



NOTICE

Do NOT use excessive force when connecting the piping. Deformation of the piping can cause malfunctioning of the unit.

To facilitate service and maintenance, 1 shut-off valve is provided. Mount the shut-off valve on the circuit filler water pipe.

- 1 Install the shut-off valve on the circuit filler pipe.
- 2 Screw the indoor unit nuts on the shut-off valve.
- 3 Connect the domestic hot water IN and OUT pipes to the indoor unit. It is obligatory to use the accessory G3 kit EKUHWG3D to comply with UK legislation. See "8.6.4 To connect the water piping for domestic hot water" [▶ 61].

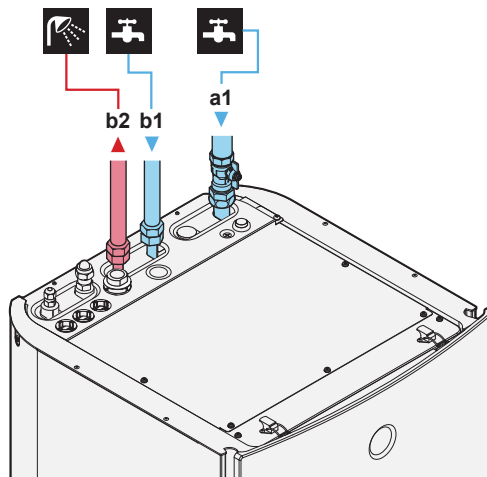

- a1** Filler circuit – Water IN (screw connection, 1")
- b1** DHW – Cold water IN (screw connection, 3/4")
- b2** DHW – Hot water OUT (screw connection, 3/4")



NOTICE

- It is recommended to install shut-off valves to domestic cold water in and domestic hot water out connections. These shut-off valves are field supplied.
- **However, make sure there is no valve between the pressure relief valve (delivered with the domestic hot water tank kit) and the DHW tank.**
- Select valves complying to EN 1487, EN 1488, EN 1489, EN 1490 and EN 1491.



NOTICE

Install air purge valves at all local high points.

8.6.4 To connect the water piping for domestic hot water

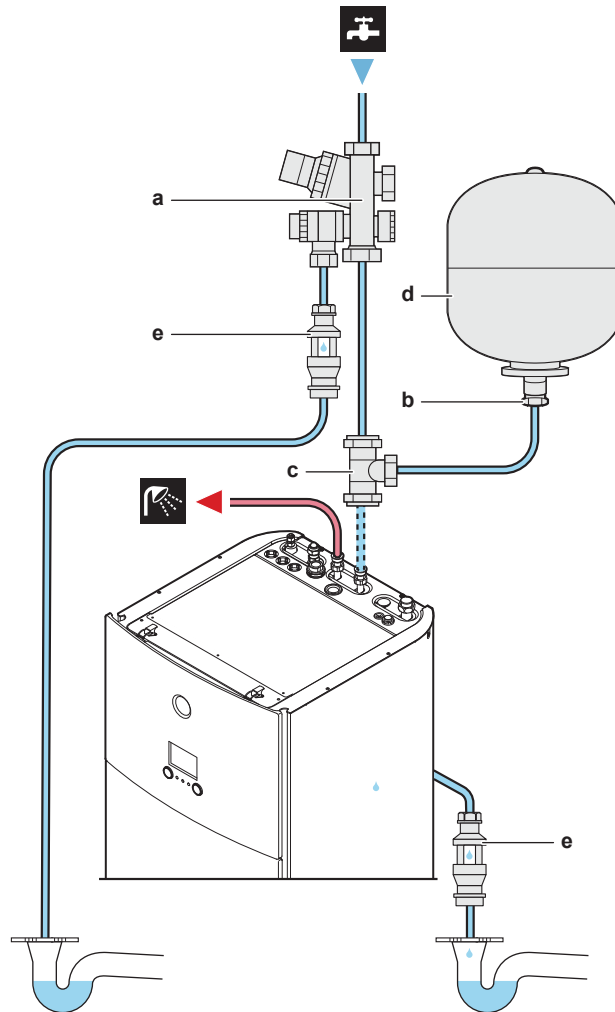

- a Pressure reducing valve/pressure relief valve combination. Water inlet and water outlet 22 mm connection, discharge piping connection 15 mm
- b Adaptor 22 mm×3/4" Female BSP
- c T-piece 22 mm×22 mm×22 mm
- d Expansion vessel of 18 l – 3/4" Male BSP
- e Tundish 15 mm inlet, 22 mm outlet

- 1 Pre-assemble the adaptor and expansion vessel so that the expansion vessel is ready for installation.

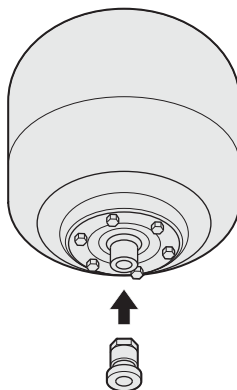

- 2 Mount the expansion vessel to the wall.

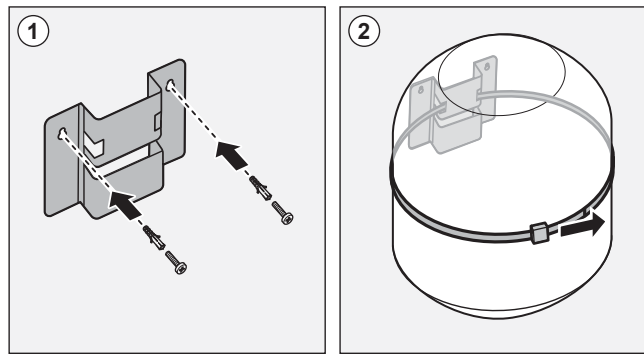

- 3 Fit the T-piece (part of the kit) to the domestic hot water cold water IN pipe of the unit.
- 4 Connect the pressure reducing valve/pressure relief valve combination (part of the kit) to the T-piece with a length of copper tube $\varnothing 22$ mm (field supply).
- 5 Connect the expansion vessel to the T-piece with a length of copper tube $\varnothing 22$ mm (field supply).
- 6 Connect the pressure reducing valve/pressure relief valve combination to the water mains inlet.
- 7 Install the tundish (part of the kit) in a vertical position within a maximum of 600 mm away from the pressure reducing valve/pressure relief valve combination.



WARNING

Install the tundish away from any electrical device. **Possible consequence:** Electrical shock or fire.



NOTICE

To ensure a free water flow through the discharge pipe, manually operate the pressure relief valve by turning its knob left.

- 8 Use the quick fixture to connect the discharge pipe (see "4.1.2 To remove the accessories from the indoor unit" [▶ 21]) to the pipe connection in the hole located at the back of the unit, and fix the pipe to the rear plate with the cable tie + clip. This pipe starts at the pressure relief valve of the domestic hot water tank. After connecting the discharge pipe, cover the hole with the antisweat sticker.

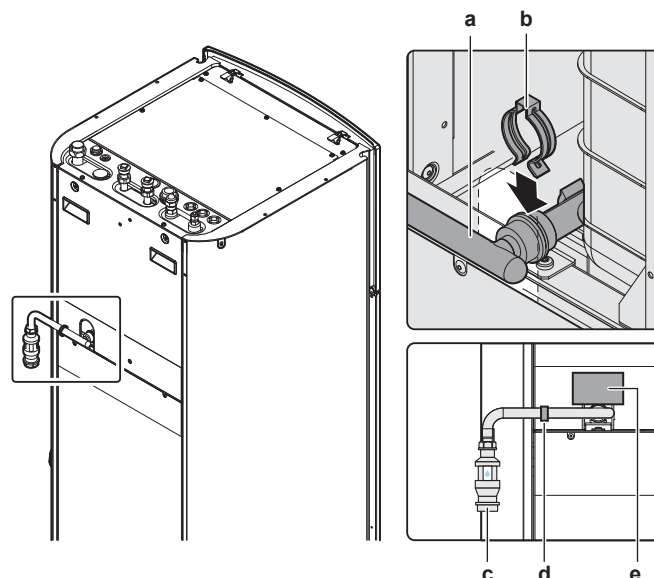

- a Discharge pipe (for pressure relief valve)
- b Quick fixture
- c Tundish
- d Cable tie + clip
- e Antisweat sticker (50×80 mm)

- 9 Connect the two tundishes (one from the pressure relief valve of the domestic hot water tank, and one from the pressure relief valve of the domestic hot water tank kit) to an appropriate drain according to the applicable legislation. The following example shows discharge below fixed grating (Building Regulation G3 section 3.61 gives alternative points of discharge):

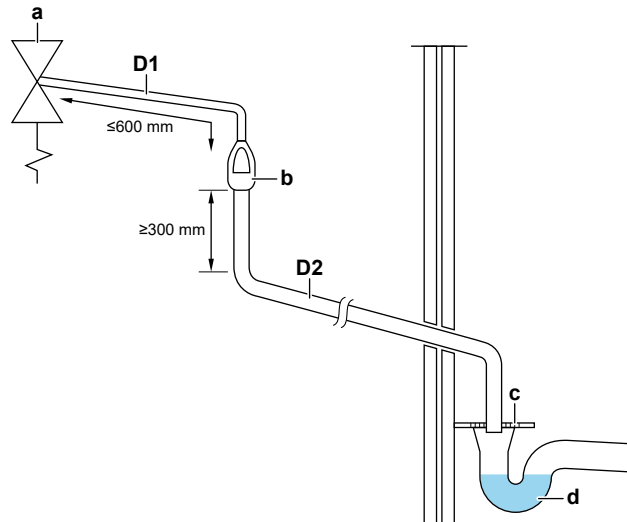

- a Safety device (pressure and temperature relief valve of domestic hot water tank; pressure relief valve of domestic hot water tank kit)
- b Tundish
- c Fixed grating
- d Trapped gully
- D1 Metal discharge pipe from safety device to tundish
- D2 Discharge pipe from tundish, with continuous fall. See Building Regulation G3 section 3.56, Table 03 and worked example.

- 10 After completing the installation, the installer MUST fill out the warning label on the tank with indelible ink, in order to comply with the building regulations. The warning label can be found in the vicinity of the nameplate.

WARNING TO USER

- a. Do not remove or adjust any component of this unvented water heater; contact the installer.
- b. If this unvented water heater develops a fault, such as a flow of hot water from the discharge pipe, switch the heater off and contact the installer.

WARNING TO INSTALLER

- a. This installation is subject to the Building Regulations.
- b. Use only appropriate components for installation or maintenance.

Installed by:

Name

Address

Tel. No.

Completion date



WARNING

The discharge pipes from the pressure relief valves MUST terminate in a safe and visible position without forming any risk to persons in the vicinity.



WARNING

- Discharge piping, tundish, drain valves, etc. **MUST** be positioned away from any electrical components.
- The discharge pipe away from the tundish **MUST** terminate in a safe, visible position without forming any risk to persons in the vicinity.



WARNING

- Do **NOT** install any valves between the domestic hot water tank and relief valves/ expansion vessel.
- Do **NOT** install shut-off valves between the expansion relief valve and the domestic hot water tank.



NOTICE

- All pipework and fittings must be flushed free of flux and debris prior to installing the domestic hot water tank kit. Failure to do this may cause irreparable damage to the tank kit controls. Flush the system by opening the hot water tap.
- The tundish pipework must be a 22 mm metal pipe with a minimal vertical length of 300 mm below the tundish before any elbows or bends in the pipework. All pipework must have a continuous fall of 1 in 200 thereafter. Maximum permitted (equivalent) length of 22 mm pipework is 9 m. Each bend or elbow is equivalent to 0.8 m of pipework.

8.6.5 To connect the recirculation piping

Prerequisite: Only required if you need recirculation in your system.

- 1 Remove the top panel from the unit, see "[7.2.2 To open the indoor unit](#)" [▶ 44].
- 2 Cut out the rubber grommet on top of the unit, and remove the stop. The recirculation connector is placed below the hole.
- 3 Route the recirculation piping through the grommet and connect it to the recirculation connector.

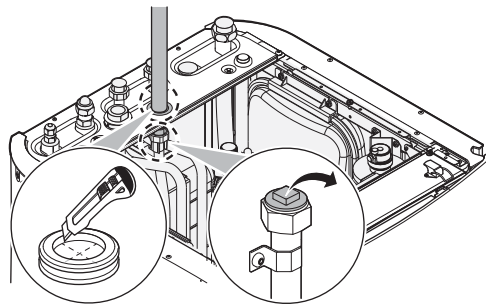

- 4 Reattach the top panel.

8.6.6 To fill the heating circuit for domestic hot water

To fill the water circuit, use a field supply filling kit. Make sure you comply with the applicable legislation.



NOTICE

Pump. To prevent blocking of the pump rotor, commission the unit as quickly as possible after filling the water circuit.

**INFORMATION**

Make sure that the air purge valve on the backup heater is open.

8.6.7 To fill the domestic hot water tank

- 1** Open every hot water tap in turn to purge air from the system pipe work.
- 2** Open the cold water supply valve.
- 3** Close all water taps after all air is purged.
- 4** Check for water leaks.
- 5** Manually operate the field-installed pressure relief valve to ensure a free water flow through the discharge pipe.

8.6.8 To insulate the water piping

The piping in the complete water circuit **MUST** be insulated to prevent reduction of the heating capacity.

9 Electrical installation



WARNING

Make sure that the electrical wiring does NOT touch the refrigerant gas pipe, which can be very hot.

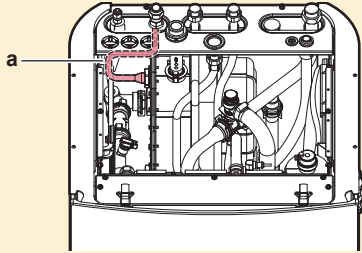

a Refrigerant gas pipe

In this chapter

9.1	About connecting the electrical wiring	66
9.1.1	Precautions when connecting the electrical wiring	66
9.1.2	Guidelines when connecting the electrical wiring	67
9.1.3	About electrical compliance	68
9.2	Connections to the indoor unit	69
9.2.1	To connect the main power supply	69
9.2.2	To connect the backup heater power supply.....	70
9.2.3	To connect the electricity meters.....	71
9.2.4	To connect the domestic hot water pump.....	72
9.3	After connecting the electrical wiring to the indoor unit.....	73

9.1 About connecting the electrical wiring

Before connecting the electrical wiring

Make sure:

- The refrigerant piping is connected and checked
- The water piping is connected

Typical workflow

Connecting the electrical wiring typically consists of the following stages:

- "9.2 Connections to the indoor unit" [▶ 69]

9.1.1 Precautions when connecting the electrical wiring



DANGER: RISK OF ELECTROCUTION



WARNING

- All wiring **MUST** be performed by an authorised electrician and **MUST** comply with the national wiring regulation.
- Make electrical connections to the fixed wiring.
- All components procured on-site and all electrical construction **MUST** comply with the applicable legislation.

**WARNING**

ALWAYS use multicore cable for power supply cables.

**INFORMATION**

Also read the precautions and requirements in the "[2 General safety precautions](#)" [▶ 9].

**WARNING**

- If the power supply has a missing or wrong N-phase, equipment might break down.
- Establish proper earthing. Do NOT earth the unit to a utility pipe, surge absorber, or telephone earth. Incomplete earthing may cause electrical shocks.
- Install the required fuses or circuit breakers.
- Secure the electrical wiring with cable ties so that the cables do NOT come in contact with sharp edges or piping, particularly on the high-pressure side.
- Do NOT use taped wires, extension cords, or connections from a star system. They can cause overheating, electrical shocks or fire.
- Do NOT install a phase advancing capacitor, because this unit is equipped with an inverter. A phase advancing capacitor will reduce performance and may cause accidents.

**CAUTION**

Do NOT push or place redundant cable length into the unit.

**NOTICE**

The distance between the high voltage and low voltage cables should be at least 50 mm.

9.1.2 Guidelines when connecting the electrical wiring

**NOTICE**

We recommend using solid (single-core) wires. If stranded wires are used, slightly twist the strands to consolidate the end of the conductor for either direct use in the terminal clamp or insertion in a round crimp-style terminal.

To prepare stranded conductor wire for installation

Method 1: Twisting conductor

- 1 Strip insulation (20 mm) from the wires.
- 2 Slightly twist the end of the conductor to create a "solid-like" connection.

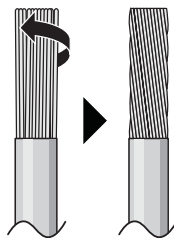

Method 2: Using round crimp-style terminal (recommended)

- 1 Strip insulation from wires and slightly twist the end of each wire.

- 2 Install a round crimp-style terminal on the end of the wire. Place the round crimp-style terminal on the wire up to the covered part and fasten the terminal with the appropriate tool.

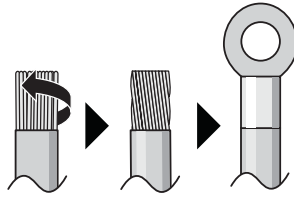

Use the following methods for installing wires:

Wire type	Installation method
Single-core wire Or Stranded conductor wire twisted to "solid-like" connection	<p>a Curled wire (single-core or twisted stranded conductor wire) b Screw c Flat washer</p>
Stranded conductor wire with round crimp-style terminal	<p>a Terminal b Screw c Flat washer ✓ Allowed ✗ NOT allowed</p>

Tightening torques

Indoor unit:



Item	Tightening torque (N•m)
X1M	2.45 ±10%
X2M	0.88 ±10%
X5M	0.88 ±10%
X6M	2.45 ±10%
X10M	0.88 ±10%
M4 (earth)	1.47 ±10%

9.1.3 About electrical compliance

Only for the backup heater of the indoor unit

See "9.2.2 To connect the backup heater power supply" [▶ 70].



9.2 Connections to the indoor unit

Item	Description
Power supply (main)	See "9.2.1 To connect the main power supply" [▶ 69].
Power supply (backup heater)	See "9.2.2 To connect the backup heater power supply" [▶ 70].
Electricity meters	See "9.2.3 To connect the electricity meters" [▶ 71].
WLAN cartridge	 See: <ul style="list-style-type: none"> Installation manual of the WLAN cartridge Installer reference guide
	 —
	 [D] Wireless gateway

9.2.1 To connect the main power supply

- 1 Connect the main power supply.

In case of normal kWh rate power supply

	Interconnection cable (= main power supply)	Wires: (3+GND)×1.5 mm ²
	—	

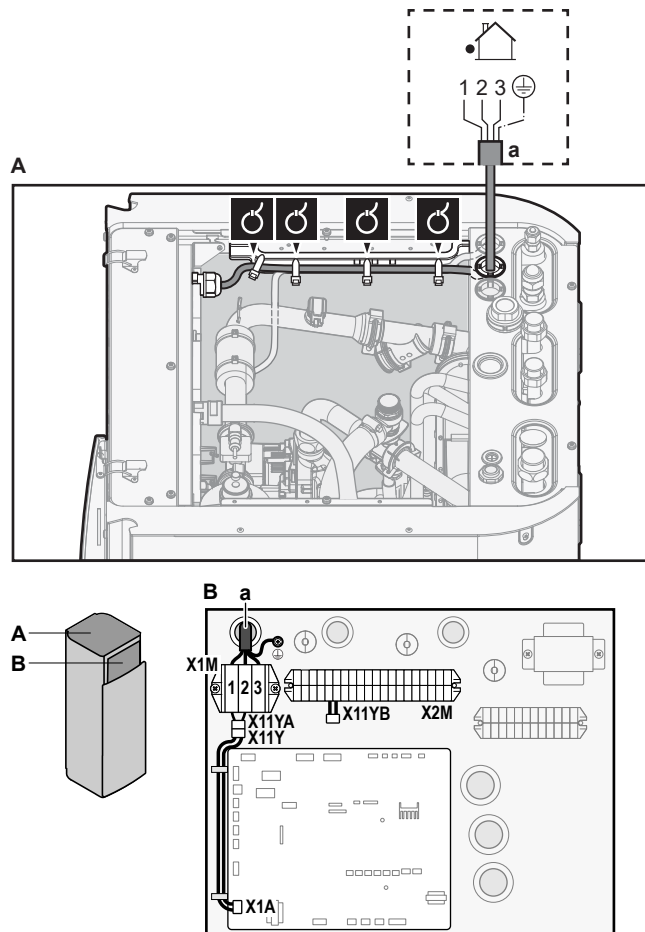

a Interconnection cable (=main power supply)

9.2.2 To connect the backup heater power supply

	Backup heater type	Power supply	Wires
	*1.5 kW BUH	1N~ 230 V	2+GND

 **WARNING**
The backup heater **MUST** have a dedicated power supply and **MUST** be protected by the safety devices required by the applicable legislation.

 **CAUTION**
To guarantee the unit is completely earthed, **ALWAYS** connect the backup heater power supply and the earth cable.

Make sure that the power supply is in accordance with the backup heater capacity, as listed in the table below.

Backup heater type	Backup heater capacity	Power supply	Maximum running current	Z _{max}
*1.5 kW BUH	1.5 kW	1N~ 230 V	6.5 A	—

Connect the backup heater power supply as follows:

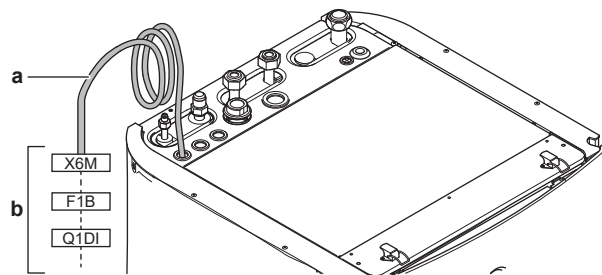

- a Factory-mounted cable connected to the contactor of the backup heater, inside the switch box (K1M)
- b Field wiring (see table below)

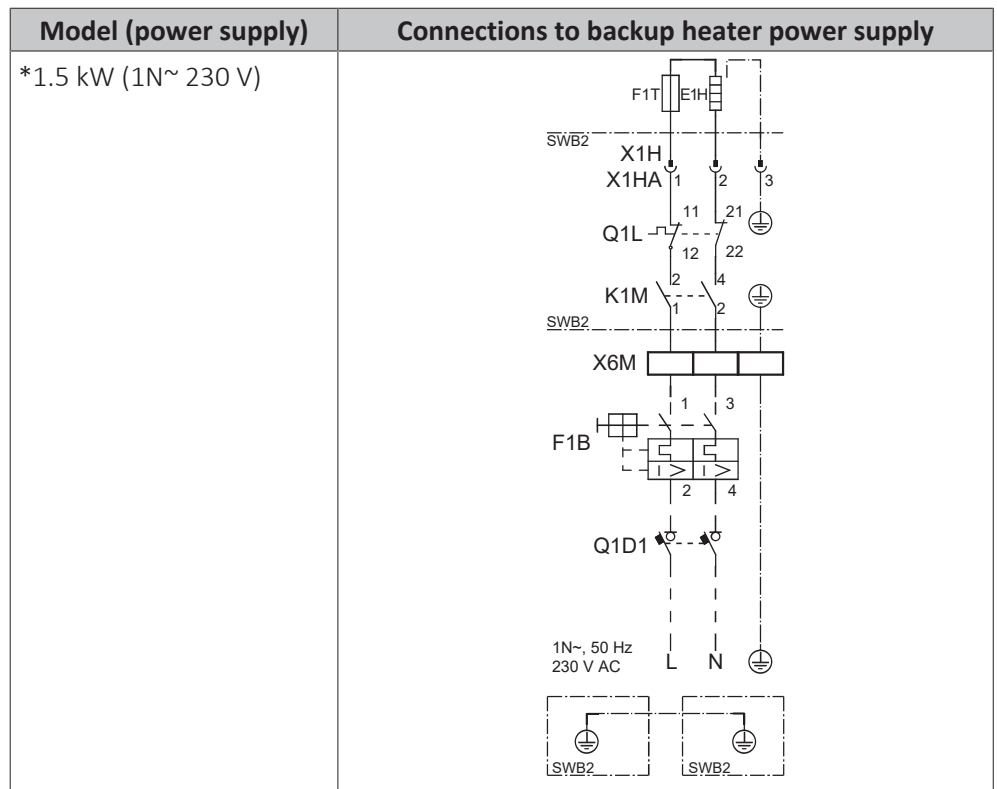

- F1B** Overcurrent fuse (field supply). Recommended fuse: 2-pole; 10 A, curve 230 V
- K1M** Contactor (in the lower switch box)
- Q1DI** Earth leakage circuit breaker (field supply)
- SWB** Switch box
- X6M** Terminal (field supply)

NOTICE
Do NOT cut or remove the backup heater power supply cable.

9.2.3 To connect the electricity meters

	Wires: 2 (per meter)×0.75 mm ² Electricity meters: 12 V DC pulse detection (voltage supplied by PCB)
	[9.A] Energy metering

INFORMATION
In case of an electricity meter with transistor output, check the polarity. The positive polarity MUST be connected to X5M/6 and X5M/4; the negative polarity to X5M/5 and X5M/3.

1 Open the following (see "7.2.2 To open the indoor unit" [▶ 44]):

1	Top panel	
2	User interface panel	
3	Upper switch box cover	

2 Connect the electricity meters cable to the appropriate terminals as shown in the illustration below.

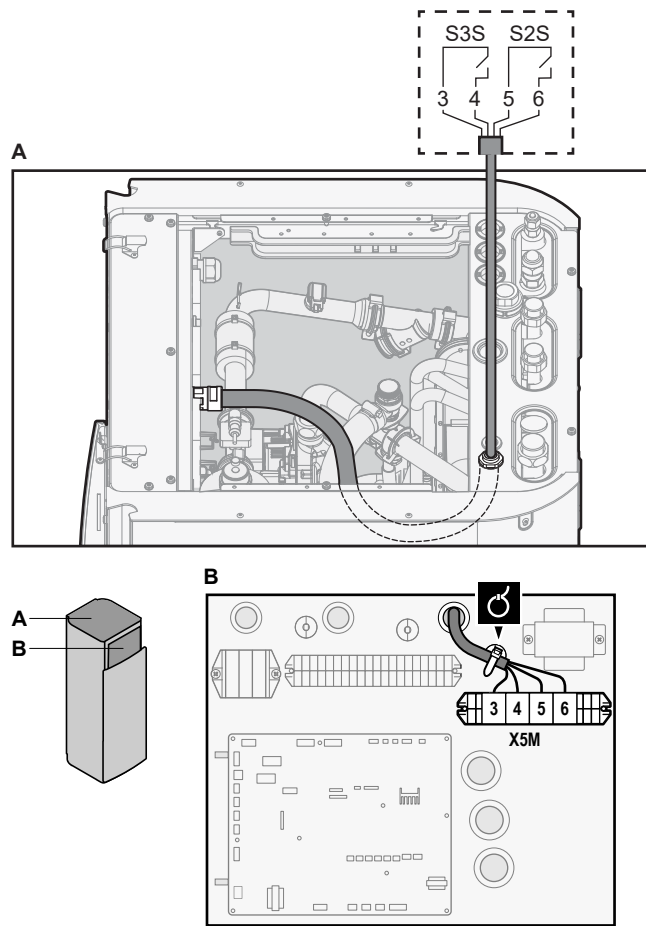

- 3 Fix the cable with cable ties to the cable tie mountings.

9.2.4 To connect the domestic hot water pump

- 1 Open the following (see "7.2.2 To open the indoor unit" [▶ 44]):

1	Top panel	
2	User interface panel	
3	Upper switch box cover	

- 2 Connect the domestic hot water pump cable to the appropriate terminals as shown in the illustration below.

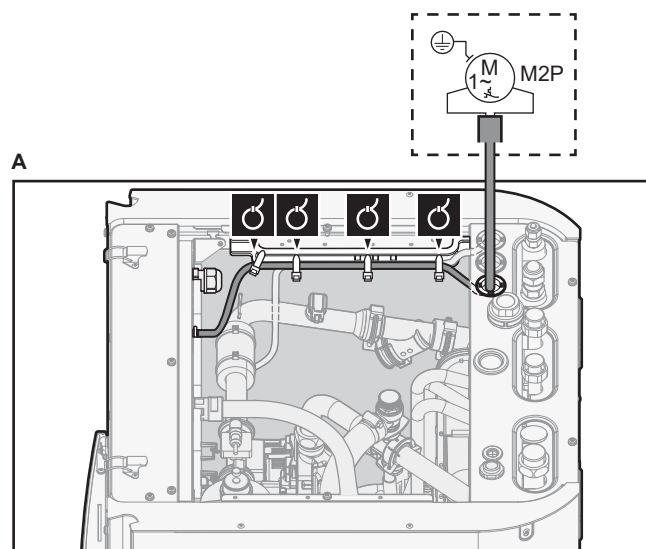

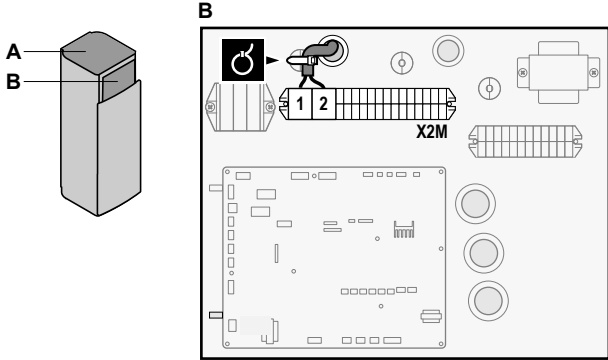

3 Fix the cable with cable ties to the cable tie mountings.

9.3 After connecting the electrical wiring to the indoor unit

To prevent water ingress to the switch box, seal the low voltage wiring intake using the sealing tape (delivered as accessory).

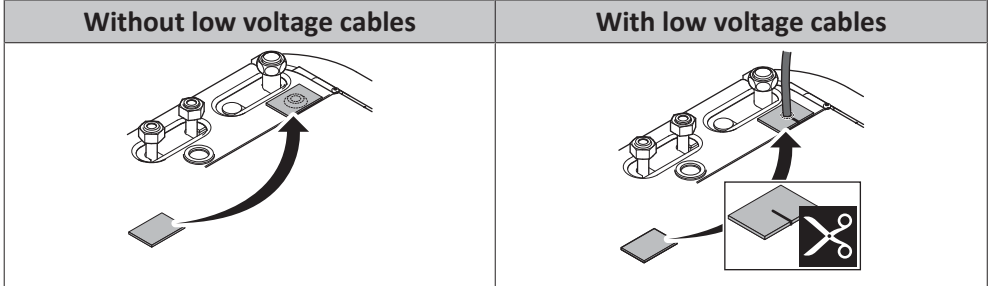

10 Configuration

In this chapter

10.1	Overview: Configuration.....	74
10.1.1	To access the most used commands.....	75
10.1.2	To connect the PC cable to the switch box.....	77
10.2	Configuration wizard.....	77
10.3	Possible screens.....	78
10.3.1	Possible screens: Overview.....	78
10.3.2	Home screen.....	79
10.3.3	Main menu screen.....	80
10.3.4	Menu screen.....	81
10.3.5	Setpoint screen.....	81
10.3.6	Detailed screen with values.....	82
10.4	Preset values and schedules.....	83
10.4.1	Using preset values.....	83
10.4.2	Using and programming schedules.....	83
10.4.3	Schedule screen: Example.....	85
10.5	Weather-dependent curve.....	88
10.5.1	What is a weather-dependent curve?.....	88
10.5.2	Slope-offset curve.....	89
10.5.3	2-points curve.....	90
10.5.4	Using weather-dependent curves.....	91
10.6	Settings menu.....	92
10.6.1	Malfunctioning.....	92
10.6.2	Tank.....	92
10.6.3	User settings.....	101
10.6.4	Information.....	104
10.6.5	Installer settings.....	105
10.6.6	Commissioning.....	111
10.6.7	User profile.....	111
10.6.8	Operation.....	111
10.6.9	WLAN.....	112
10.7	Menu structure: Overview user settings.....	115
10.8	Menu structure: Overview installer settings.....	116

10.1 Overview: Configuration

This chapter describes what you have to do and know to configure the system after it is installed.

Why

If you do NOT configure the system correctly, it might NOT work as expected. The configuration influences the following:

- The calculations of the software
- What you can see on and do with the user interface

How

You can configure the system via the user interface.

- **First time – Configuration wizard.** When you turn ON the user interface for the first time (via the unit), the configuration wizard starts to help you configure the system.
- **Restart the configuration wizard.** If the system is already configured, you can restart the configuration wizard. To restart the configuration wizard, go to **Installer settings > Configuration wizard**. To access **Installer settings**, see "[10.1.1 To access the most used commands](#)" [▶ 75].

- **Afterwards.** If necessary, you can make changes to the configuration in the menu structure or the overview settings.



INFORMATION

When the configuration wizard is finished, the user interface will show an overview screen and request to confirm. When confirmed, the system will restart and the home screen will be displayed.

Accessing settings – Legend for tables

You can access the installer settings using two different methods. However, NOT all settings are accessible via both methods. If so, the corresponding table columns in this chapter are set to N/A (not applicable).

Method	Column in tables
Accessing settings via the breadcrumb in the home menu screen or the menu structure . To enable breadcrumbs, press the ? button in the home screen.	# For example: [2.9]
Accessing settings via the code in the overview field settings .	Code For example: [C-07]





See also:

- ["To access the installer settings" \[▶ 76\]](#)
- ["10.8 Menu structure: Overview installer settings" \[▶ 116\]](#)

10.1.1 To access the most used commands

To change the user permission level

You can change the user permission level as follows:

1	Go to [B]: User profile. 	
2	Enter the applicable pin code for the user permission level.	—
	▪ Browse through the list of digits and change the selected digit.	
	▪ Move the cursor from left to right.	
	▪ Confirm the pin code and proceed.	

Installer pin code

The **Installer** pin code is **5678**. Additional menu items and installer settings are now available.

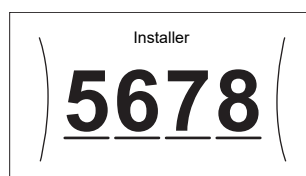

Advanced user pin code

The **Advanced user** pin code is **1234**. Additional menu items for the user are now visible.



User pin code

The **User** pin code is **0000**.

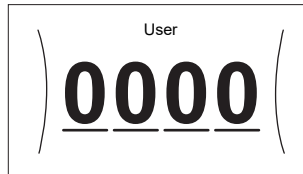

To access the installer settings



- 1 Set the user permission level to **Installer**.
- 2 Go to [9]: **Installer settings**.

To modify an overview setting

Example: Modify [1-01] from 15 to 20.

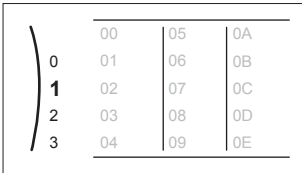
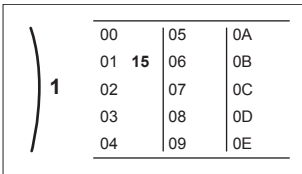
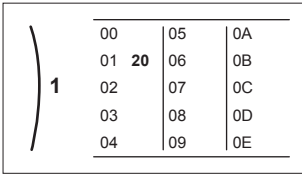
Most settings can be configured via the menu structure. If for any reason it is required to change a setting using the overview settings, then the overview settings can be accessed as follows:

1	Set the user permission level to Installer . See " To change the user permission level " [▶ 75].	—
2	Go to [9.1]: Installer settings > Overview field settings .	
3	Turn the left dial to select the first part of the setting and confirm by pressing the dial. 	
4	Turn the left dial to select the second part of the setting 	
5	Turn the right dial to modify the value from 15 to 20. 	

6	Press the left dial to confirm the new setting.	
7	Press the center button to go back to the home screen.	

**INFORMATION**

When you change the overview settings and you go back to the home screen, the user interface will show a popup screen and request to restart the system.

When confirmed, the system will restart and recent changes will be applied.

10.1.2 To connect the PC cable to the switch box

This connection between PC and hydro PCB is needed when updating the hydro software and EEPROM.

Prerequisite: The EKPCAB4 kit is required.

- 1 Connect the USB connector of the cable to your PC.
- 2 Connect the plug of the cable to X10A on A1P of the switch box of the indoor unit.

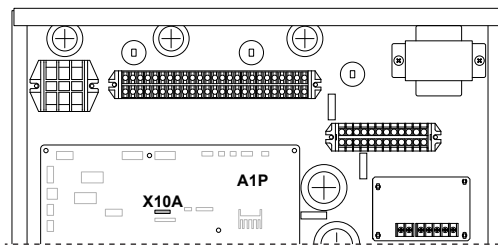

- 3 Pay special attention to the position of the plug!

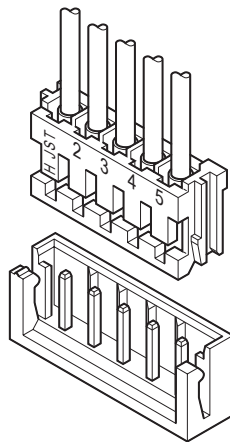

10.2 Configuration wizard

After first power ON of the system, the user interface starts a configuration wizard. Use this wizard to set the most important initial settings for the unit to run properly. If required, you can afterwards configure more settings. You can change all these settings via the menu structure.

You can find a short overview of the settings in the configuration here. All the settings can also be adjusted in the settings menu (use the breadcrumbs).

For the setting...	Refer to...
Language [7.1]	
Time/date [7.2]	

For the setting...		Refer to...
Hours		—
Minutes		
Year		
Month		
Day		
System		
Indoor unit type (read only)		"10.6.5 Installer settings" [▶ 105]
Backup heater type [9.3.1] (read only)		
Voltage [9.3.2]		
Configuration [9.3.3]		
Capacity step 1 [9.3.4]		
Quick mode timer [9.3.A]		
BUH allowance schedule [9.3.B]		
Operation [9.3.8]		
Emergency [9.5]		
Tank		
Heat up mode [5.6]		"10.6.2 Tank" [▶ 92]
Disinfection [5.7]		
Maximum [5.8]		
Hysteresis [5.9]		
Hysteresis [5.A]		
Comfort setpoint [5.2]		
Eco setpoint [5.3]		
Reheat setpoint [5.4]		
Setpoint mode [5.B]		
WD curve type [5.E]		
Operation modes [5.G]		

10.3 Possible screens

10.3.1 Possible screens: Overview

The most common screens are as follows:

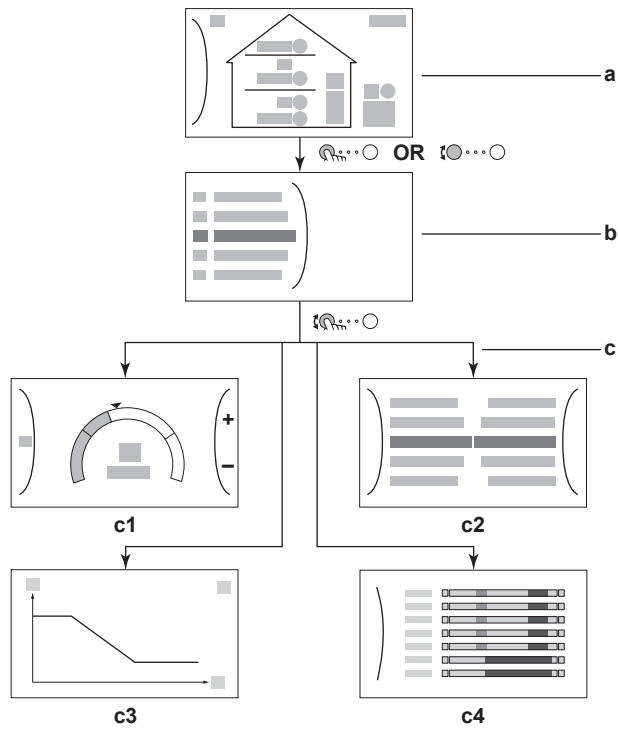







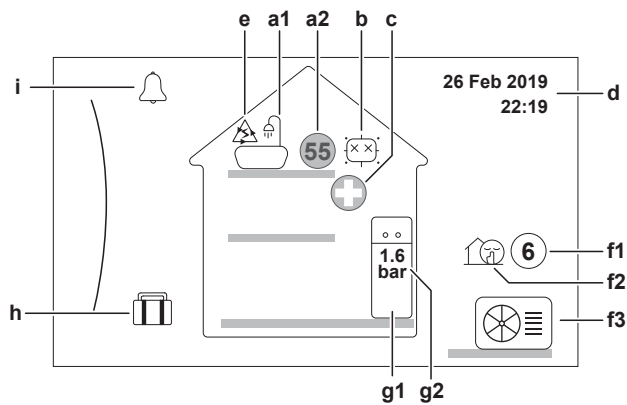





- a** Home screen
- b** Main menu screen
- c** Lower level screens:
 - c1:** Setpoint screen
 - c2:** Detailed screen with values
 - c3:** Screen with weather-dependent curve
 - c4:** Screen with schedule

10.3.2 Home screen

Press the button to go back to the home screen. You see an overview of the unit configuration and the room and setpoint temperatures. Only symbols applicable for your configuration are visible on the home screen.





Possible actions on this screen	
	Go through the list of the main menu.
	Go to the main menu screen.
?	Enable/disable breadcrumbs.

Item	Description	
a	Domestic hot water	
a1		Domestic hot water
a2		Measured tank temperature ^(a)
b	Disinfection / Powerful	
		Disinfection mode active
		Powerful operation mode active
c	Emergency	
		Heat pump failure and system operates in Emergency mode.
d	Current date and time	
e	Smart energy	
		Smart energy is currently being used for domestic hot water.
f	Outdoor / quiet mode	
f1		Measured outdoor temperature ^(a)
f2		Quiet mode active
f3		Outdoor unit
g	Indoor unit / domestic hot water tank	
g1		Domestic hot water tank
g2	1.6 bar	Water pressure
h	Holiday mode	
		Holiday mode active
i	Malfunction	
		A malfunction occurred.
		See " 14.4.1 To display the help text in case of a malfunction " [▶ 134] for more information.

^(a) If the corresponding operation is not active, the circle is greyed out.

10.3.3 Main menu screen

Starting from the home screen, press () or turn () the left dial to open the main menu screen. From the main menu, you can access the different setpoint screens and submenus.

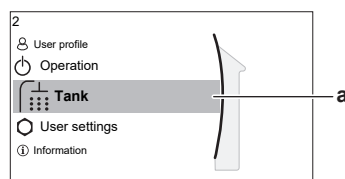

a Selected submenu

Possible actions on this screen	
	Go through the list.
	Enter the submenu.
	Enable/disable breadcrumbs.

Submenu	Description
[0] or Malfunctioning	Restriction: Only displayed if a malfunction occurs. See " 14.4.1 To display the help text in case of a malfunction " [▶ 134] for more information.
[5] Tank	Set the domestic hot water tank temperature.
[7] User settings	Gives access to user settings such as holiday mode and quiet mode.
[8] Information	Displays data and information about the indoor unit.
[9] Installer settings	Restriction: Only for the installer. Gives access to advanced settings.
[A] Commissioning	Restriction: Only for the installer. Perform tests and maintenance.
[B] User profile	Change the active user profile.
[C] Operation	Turn heating/cooling functionality and domestic hot water preparation on or off.
[D] Wireless gateway	Restriction: Only displayed if a wireless LAN (WLAN) is installed. Contains settings needed when configuring the ONECTA app.

10.3.4 Menu screen



Example:

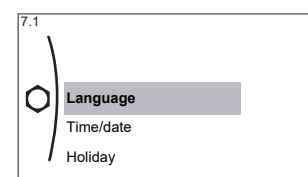

Possible actions on this screen	
	Go through the list.
	Enter the submenu/setting.

10.3.5 Setpoint screen

The setpoint screen is displayed for screens describing system components that need a setpoint value.

Example

[5] Tank temperature screen

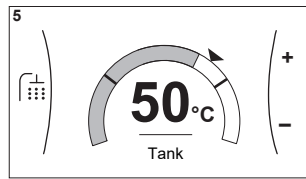

Explanation

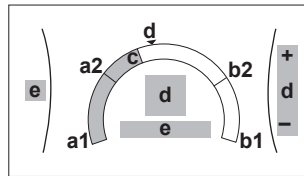

Possible actions on this screen	
	Go through the list of the submenu.
	Go to the submenu.
	Adjust and automatically apply the desired temperature.

Item	Description	
Minimum temperature limit	a1	Fixed by the unit
	a2	Restricted by the installer
Maximum temperature limit	b1	Fixed by the unit
	b2	Restricted by the installer
Current temperature	c	Measured by the unit
Desired temperature	d	Turn the right dial to increase/ decrease (for Reheat only mode).
SubMenu	e	Turn or press the left dial to go to the submenu.

10.3.6 Detailed screen with values

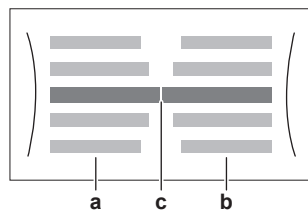

- a** Settings
- b** Values
- c** Selected setting and value

Example:

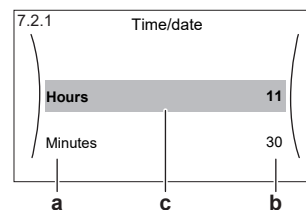

Possible actions on this screen	
	Go through the list of settings.
	Change the value.
	Go to the next setting.

Possible actions on this screen	
	Confirm changes and proceed.

10.4 Preset values and schedules

10.4.1 Using preset values

About preset values

For some settings in the system, you can define preset values. You only need to set these values one time, then reuse the values in other screens such as the scheduling screen. If you later want to change the value, you only have to do it in one place.

Possible preset values

You can set the following user-defined preset values:

Preset value		Where used
Tank target temperature, Operation mode, Quick mode timer	[5.2] Comfort setpoint	You can use these preset values in [5.5] Schedule (weekly schedule screen for the DHW tank) if the DHW tank mode is one of the following: <ul style="list-style-type: none"> Schedule only Schedule + reheat
	[5.3] Eco setpoint	
	[5.4] Reheat setpoint	The software uses this preset value if the DHW tank mode is Schedule + reheat
	[5.G] Operation mode	You can select two type of DHW operation which concerns allowance of backup heater: <ul style="list-style-type: none"> Efficient Quick
	[5.H] Quick mode timer	This timer is only applicable if "Quick " is chosen as the Operation mode. Three preset timer can be selected: <ul style="list-style-type: none"> Turbo (10 minutes) Normal (20 minutes) Economic (30 minutes)

Additional to the user-defined preset values, the system also contains some system-defined preset values that you can use when programming schedules.

Example: In [7.4.2] User settings > Quiet > Schedule (weekly schedule for when the unit has to use which quiet mode level), you can use the following system-defined preset values: Quiet/More quiet/Most quiet.

10.4.2 Using and programming schedules

About schedules

Depending on your system layout and installer configuration, schedules for multiple controls may be available.

You can...	See...
Set if a specific control needs to act according to a schedule.	" Activation screen " in " Possible schedules " [▶ 84]
Select which schedule you currently want to use for a specific control. The system contains some predefined schedules. You can:	
Consult which schedule is currently selected.	" Schedule/Control " in " Possible schedules " [▶ 84]
Program your own schedules if the predefined schedules are not satisfactory. The actions you can program are control specific.	<ul style="list-style-type: none"> ▪ "Possible actions" in "Possible schedules" [▶ 84] ▪ "10.4.3 Schedule screen: Example" [▶ 85]

To select which schedule you currently want to use

Possible schedules

The table contains the following information:

- **Schedule/Control:** This column shows you where you can consult the currently selected schedule for the specific control. If needed, you can:
 - Program your own schedule. See "[10.4.3 Schedule screen: Example](#)" [▶ 85].
- **Predefined schedules:** (if applicable) The predefined schedule in the system for the specific control. If needed, you can program your own schedule.
- **Activation screen:** For most controls, a schedule is only effective if it activated in its corresponding activation screen. This entry shows you where to activate it.
- **Possible actions:** Actions you can use when programming a schedule.

Schedule/Control	Description
<p>[5.5] Tank > Schedule</p> <p>Schedule for the domestic hot water tank temperature for your normal domestic hot water needs.</p>	<p>Predefined schedules: Not applicable</p> <p>Activation screen: Not applicable. This schedule is automatically activated if the DHW mode is one of the following:</p> <ul style="list-style-type: none"> ▪ Schedule only ▪ Schedule + reheat <p>Possible actions:</p> <ul style="list-style-type: none"> ▪ Comfort: When to start heating the tank to the user-defined preset value [5.2] Comfort setpoint. ▪ Eco: When to start heating the tank to the user-defined preset value [5.3] Eco setpoint. ▪ Stop: When to stop heating the tank, even if the desired tank temperature is not reached yet. <p>Note: In Schedule + reheat mode, the system also takes the user-defined preset value [5.4] Reheat setpoint into account.</p>

Schedule/Control	Description
<p>[5.F] Tank > Priority schedule</p> <p>Schedule for the outdoor unit to determine priority between domestic hot water tank operation and air conditioning</p>	<p>Predefined schedules: Domestic hot water as priority for each month</p> <p>Activation screen: Not applicable. This schedule is only used when more than one indoor unit (e.g. 1 tank + 1 A/C unit) connected to outdoor unit.</p> <p>Possible actions:</p> <ul style="list-style-type: none"> ▪ DHW : If there are requests from multiple indoor units at the same time, the outdoor unit will prioritize domestic hot water production. ▪ A/C : If there are request from multiple indoor units at the same time, outdoor unit will prioritize Air Conditioning (heating/cooling) operation.
<p>[7.4.2] User settings > Quiet > Schedule</p> <p>Schedule for when the unit has to use which quiet mode level.</p>	<p>Predefined schedule: Not applicable</p> <p>Activation screen: [7.4.1] Mode (only available to installers).</p> <p>Possible actions: You can use the following system-defined preset values:</p> <ul style="list-style-type: none"> ▪ Off ▪ Quiet ▪ More quiet ▪ Most quiet <p>See "About quiet mode" [▶ 102].</p>

10.4.3 Schedule screen: Example

This example shows how to set a tank heat up schedule.

To program the schedule: overview

Example: You want to program the following schedule:

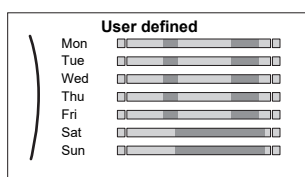





- 1 Go to the schedule.
- 2 (optional) Clear the content of the whole week schedule or the content of a selected day schedule.
- 3 Program the schedule for **Monday**.
- 4 Copy the schedule to the other weekdays.
- 5 Program the schedule for **Saturday** and copy it to **Sunday**.



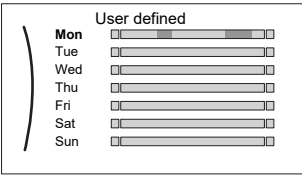

To go to the schedule

1	Go to [5.5]: Tank > Schedule.	
---	-------------------------------	--



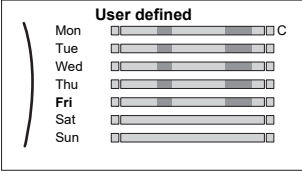

To clear the content of the week schedule

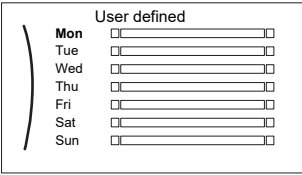

<p>1</p>	<p>Select the name of the current schedule.</p> 	
<p>2</p>	<p>Select Delete.</p> 	
<p>3</p>	<p>Select OK to confirm.</p>	

To clear the content of a day schedule

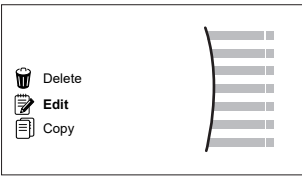



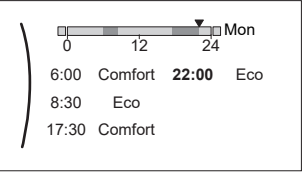

<p>1</p>	<p>Select the day of which you want to clear the content. For example Friday</p> 	
<p>2</p>	<p>Select Delete.</p> 	
<p>3</p>	<p>Select OK to confirm.</p>	

To program the schedule for Monday

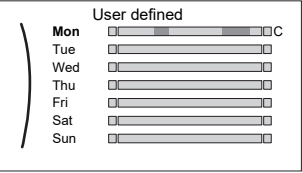
<p>1</p>	<p>Select Monday.</p> 	
<p>2</p>	<p>Select Edit.</p> 	

<p>3</p>	<p>Use the left dial to select an entry and edit the entry with the right dial. You can program up to 4 actions each day.</p>  <p>Note: To clear an action, set its time as the time of the previous action.</p>	
<p>4</p>	<p>Confirm the changes.</p> <p>Result: The schedule for Monday is defined. The value of the last action is valid until the next programmed action. In this example, Monday is the first day you programmed. Thus, the last programmed action is valid up to the first action of next Monday.</p>	

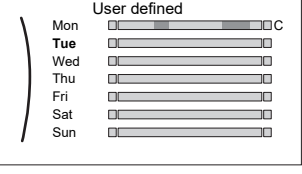
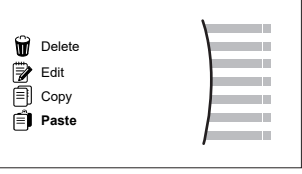
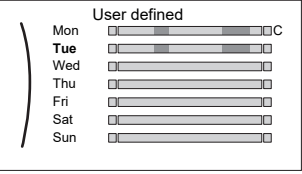
To copy the schedule to the other weekdays

<p>1</p>	<p>Select Monday.</p> 	
<p>2</p>	<p>Select Copy.</p>  <p>Result: Next to the copied day, "C" is displayed.</p>	
<p>3</p>	<p>Select Tuesday.</p> 	
<p>4</p>	<p>Select Paste.</p>  <p>Result:</p> 	

Weather-dependent curve

To be able to compensate for differences in temperature, the unit relies on its weather-dependent curve. This curve defines how much the temperature of the tank or leaving water must be at different outdoor temperatures. Because the slope of the curve depends on local circumstances such as climate and the insulation of the building, the curve can be adjusted by an installer or user.

Types of weather-dependent curve

There are 2 types of weather-dependent curves:

- 2-points curve
- Slope-offset curve

Which type of curve you use to make adjustments, depends on your personal preferences. See "[10.5.4 Using weather-dependent curves](#)" [▶ 91].

Availability

The weather-dependent curve is available for:

- Tank



INFORMATION

To operate weather-dependent, correctly configure the setpoint of the tank. See "[10.5.4 Using weather-dependent curves](#)" [▶ 91].

10.5.2 Slope-offset curve

Slope and offset

Define the weather-dependent curve by its slope and offset:

- Change the **slope** to differently increase or decrease the target temperature of the tank for different ambient temperatures. For example, if tank water temperature is in general fine but at low ambient temperatures too cold, raise the slope so that the tank temperature is heated increasingly more at decreasingly lower ambient temperatures.
- Change the **offset** to equally increase or decrease the target temperature of the tank for different ambient temperatures. For example, if the tank temperature is always a bit too cold at different ambient temperatures, shift the offset up to equally increase the tank target temperature for all ambient temperatures.

Examples



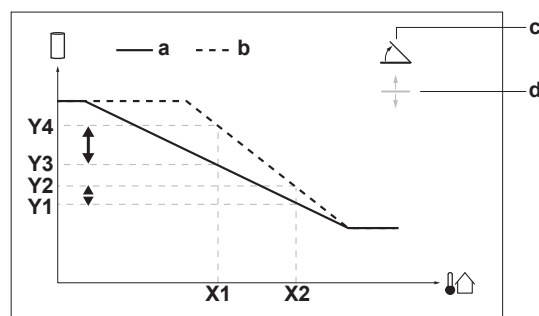

Weather-dependent curve when slope is selected:

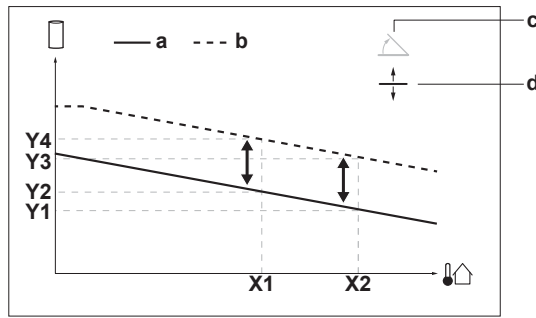

Weather-dependent curve when offset is selected:



Item	Description
a	WD curve before changes.
b	WD curve after changes (as example): <ul style="list-style-type: none"> ▪ When slope is changed, the new preferred temperature at X1 is unequally higher than the preferred temperature at X2. ▪ When offset is changed, the new preferred temperature at X1 is equally higher as the preferred temperature at X2.
c	Slope
d	Offset
X1, X2	Examples of outdoor ambient temperature
Y1, Y2, Y3, Y4	Examples of desired tank temperature. The icon corresponds to the domestic hot water tank: <ul style="list-style-type: none"> ▪ : Domestic hot water tank

Possible actions on this screen	
	Select slope or offset.
	Increase or decrease the slope/offset.
	When slope is selected: set slope and go to offset. When offset is selected: set offset.
	Confirm changes and return to the submenu.

10.5.3 2-points curve



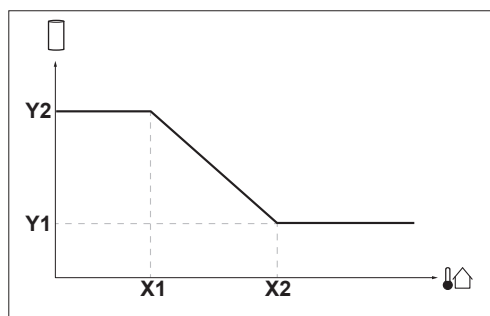

Define the weather-dependent curve with these two setpoints:

- Setpoint (X1, Y2)
- Setpoint (X2, Y1)

Example



Item	Description
X1, X2	Examples of outdoor ambient temperature

Item	Description
Y1, Y2	Examples of desired tank temperature. The icon corresponds to the domestic hot water tank: <ul style="list-style-type: none"> : Domestic hot water tank
Possible actions on this screen	
	Go through the temperatures.
	Change the temperature.
	Go to the next temperature.
	Confirm changes and proceed.

10.5.4 Using weather-dependent curves

Configure weather-dependent curves as following:

To define the setpoint mode

To use the weather-dependent curve, you need to define the correct setpoint mode.

Go to setpoint mode ...	Set the setpoint mode to ...
Tank	
[5.B] Tank > Setpoint mode	Restriction: Only available to installers. Weather dependent

To change the type of weather-dependent curve

To change the type of the weather-dependent curve for the tank, go to [5.E] Tank > WD curve type

Restriction: Only available for installers.

To change the weather-dependent curve

Zone	Go to ...
Tank	Restriction: Only available to installers. [5.C] Tank > WD curve



INFORMATION

Maximum and minimum setpoints

You cannot configure the curve with temperatures that are higher or lower than the set maximum and minimum setpoints for the tank. When the maximum or minimum setpoint is reached, the curve flattens out.

To fine-tune the weather-dependent curve: slope-offset curve

The following table describes how to fine-tune the weather-dependent curve of the tank:

The domestic hot water temperature is ...		Fine-tune with slope and offset:	
At regular outdoor temperatures ...	At cold outdoor temperatures ...	Slope	Offset
Hot	OK	↑	↓

The domestic hot water temperature is ...		Fine-tune with slope and offset:	
At regular outdoor temperatures ...	At cold outdoor temperatures ...	Slope	Offset
Hot	Cold	↑	↓
Hot	Hot	–	↓

See "10.5.2 Slope-offset curve" [▶ 89].

To fine-tune the weather-dependent curve: 2-points curve

The following table describes how to fine-tune the weather dependent curve of the tank:

The domestic hot water temperatures is ...		Fine-tune with setpoints:			
At regular outdoor temperatures ...	At cold outdoor temperatures ...	Y2 ^(a)	Y1 ^(a)	X1 ^(a)	X2 ^(a)
OK	Cold	↑	–	↑	–
OK	Hot	↓	–	↓	–
Cold	OK	–	↑	–	↑
Cold	Cold	↑	↑	↑	↑
Cold	Hot	↓	↑	↓	↑
Hot	OK	–	↓	–	↓
Hot	Cold	↑	↓	↑	↓
Hot	Hot	↓	↓	↓	↓

^(a) See "10.5.3 2-points curve" [▶ 90].

10.6 Settings menu

You can set additional settings using the main menu screen and its submenus. The most important settings are presented here.

10.6.1 Malfunctioning

In case of a malfunction, 🔔 or ⚠️ will appear on the home screen. To display the error code, open the menu screen and go to [0] **Malfunctioning**. Press ? for more information about the error.

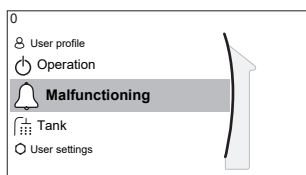

10.6.2 Tank

Overview

The following items are listed in the submenu:

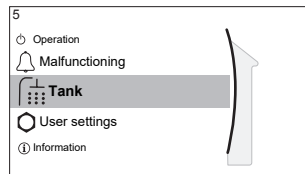

[5] Tank

Setpoint screen

[5.1] Powerful operation

[5.2] Comfort setpoint

[5.3] Eco setpoint

[5.4] Reheat setpoint

[5.5] Schedule

[5.6] Heat up mode

[5.7] Disinfection

[5.8] Maximum

[5.9] Hysteresis

[5.A] Hysteresis

[5.B] Setpoint mode

[5.C] WD curve

[5.D] Margin

[5.E] WD curve type

[5.F] Priority schedule

[5.G] Operation mode

[5.H] Quick mode timer



INFORMATION

To make tank defrost possible, we recommend a minimum tank temperature of 35°C.

Tank setpoint screen

You can set the domestic hot water temperature using the setpoint screen. For more information about how to do this, see "[10.3.5 Setpoint screen](#)" [▶ 81].

Powerful operation

You can use powerful operation to immediately start heating up the water to the preset value (**Comfort setpoint**). This activates both heat pump and electrical backup heater, which results in extra energy consumption. If powerful operation is active, will be shown on the home screen.

To activate powerful operation

Activate or deactivate **Powerful operation** as follows:

1	Go to [5.1]: Tank > Powerful operation	
2	Turn powerful operation Off or On.	

Usage example: You immediately need more hot water

If you are in the following situation:

- You already consumed most of your hot water.
- You cannot wait for the next scheduled action to heat up the storage tank.

Then you can activate DHW powerful operation.

Advantage: The storage tank is immediately heated up to the **Comfort setpoint**.

**INFORMATION**

When the Priority Schedule is set to DHW (refer to Priority schedule) and powerful operation is active, the risk of Air Conditioning (cooling /heating) and capacity shortage comfort problems is significant. In case of frequent domestic hot water operation, frequent and long Air Conditioning (cooling /heating) interruptions will happen.

Comfort setpoint

Only applicable when domestic hot water preparation is **Schedule only** or **Schedule + reheat**. When programming the schedule, you can make use of the comfort setpoint as a preset value. When you later want to change the storage setpoint, you only have to do it in one place.

The tank will heat up until the **storage comfort temperature** has been reached. It is the higher desired temperature when a storage comfort action is scheduled.

Additionally, a storage stop can be programmed. This feature puts a stop to tank heating even if the setpoint has NOT been reached. Only program a storage stop when tank heating is absolutely undesirable.

#	Code	Description
[5.2]	[6-0A]	Comfort setpoint: ▪ 30°C~[6-0E]°C

Eco setpoint

The **storage economic temperature** denotes the lower desired tank temperature. It is the desired temperature when a storage economic action is scheduled (preferably during day).

#	Code	Description
[5.3]	[6-0B]	Eco setpoint: ▪ 30°C~min(50,[6-0E])°C

Reheat setpoint

Desired reheat tank temperature, used:

- in **Schedule + reheat** mode, during reheat mode: the guaranteed minimum tank temperature is set by the **Reheat setpoint** minus the reheat hysteresis. If the tank temperature drops below this value, the tank is heated up.

#	Code	Description
[5.4]	[6-0C]	Reheat setpoint: ▪ 30°C~min(50,[6-0E])°C

Schedule

You can set the tank temperature schedule using the schedule screen. For more information about this screen, see "[10.4.3 Schedule screen: Example](#)" [▶ 85].

Heat up mode

The domestic hot water can be prepared in 3 different ways. They differ from each other by the way the desired tank temperature is set and how the unit acts upon it.

#	Code	Description
[5.6]	[6-0D]	<p>Heat up mode:</p> <ul style="list-style-type: none"> 0: Reheat only: Only reheat operation is allowed. 1: Schedule + reheat: The domestic hot water tank is heated according to a schedule and between the scheduled heat up cycles, reheat operation is allowed. 2: Schedule only: The domestic hot water tank can ONLY be heated according to a schedule.

See the operation manual for more details.

Disinfection

Applies only to installations with a domestic hot water tank.

The disinfection function disinfects the domestic hot water tank by periodically heating the domestic hot water to a specific temperature.



CAUTION

The disinfection function settings MUST be configured by the installer according to the applicable legislation.

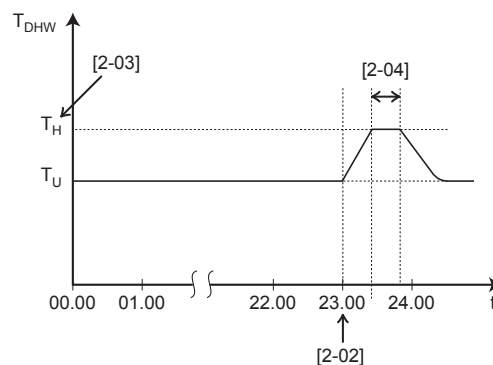

T_{DHW} Domestic hot water temperature
 T_U User setpoint temperature
 T_H High setpoint temperature [2-03]
 t Time



WARNING

Be aware that the domestic hot water temperature at the hot water tap will be equal to the value selected in field setting [2-03] after a disinfection operation.

When the high domestic hot water temperature can be a potential risk for human injuries, a mixing valve (field supply) shall be installed at the hot water outlet connection of the domestic hot water tank. This mixing valve shall secure that the hot water temperature at the hot water tap never rise above a set maximum value. This maximum allowable hot water temperature shall be selected according to the applicable legislation.



CAUTION

Make sure that the disinfection function start time [5.7.3] with defined duration [5.7.5] is NOT interrupted by possible domestic hot water demand.



NOTICE

Disinfection mode. Even if you turn OFF tank heating operation ([C.3]: **Operation** > **Tank**), disinfection mode will remain active. However, if you turn it OFF while disinfection is running, an AH error occurs.



INFORMATION

In case of error code AH and no interruption of the disinfection function occurred due to domestic hot water tapping, following actions are recommended:

- When the **Reheat only** or **Schedule + reheat** mode is selected, it is recommended to program the start-up of the disinfection function at least 4 hours later than the last expected large hot water tapping. This start-up can be set by installer settings (disinfection function).
- When the **Schedule only** mode is selected, it is recommended to program an **Eco** action 3 hours before the scheduled start-up of the disinfection function to preheat the tank.



INFORMATION

Disinfection function is restarted in case the domestic hot water temperature drops 5°C below the disinfection target temperature within the duration time.

Maximum DHW temperature setpoint

The maximum temperature that users can select for the domestic hot water. You can use this setting to limit the temperatures at the hot water taps.



INFORMATION

During disinfection of the domestic hot water tank, the DHW temperature can exceed this maximum temperature.



INFORMATION

Limit the maximum hot water temperature according to the applicable legislation.

#	Code	Description
[5.8]	[6-0E]	<p>Maximum:</p> <p>The maximum temperature that users can select for the domestic hot water. You can use this setting to limit the temperature at the hot water taps.</p> <p>The maximum temperature is NOT applicable during disinfection function. See disinfection function.</p>

Hysteresis (heat pump ON hysteresis)

Applicable when domestic hot water preparation is reheat only. When the tank temperature drops below the reheat temperature minus the heat pump ON hysteresis temperature, the tank heats up to the reheat temperature.

#	Code	Description
[5.9]	[6-00]	<p>Heat pump ON hysteresis</p> <ul style="list-style-type: none"> ▪ 2°C~40°C

Hysteresis (reheat hysteresis)

Applicable when domestic hot water preparation is scheduled+reheat. When the tank temperature drops below the reheat temperature minus the reheat hysteresis temperature, the tank heats up to the reheat temperature.

#	Code	Description
[5.A]	[6-08]	Reheat hysteresis <ul style="list-style-type: none"> ▪ 2°C~20°C

Setpoint mode

#	Code	Description
[5.B]	N/A	Setpoint mode: <ul style="list-style-type: none"> ▪ Fixed ▪ Weather dependent

WD curve

When weather-dependent operation is active the desired tank temperature is determined automatically depending on the averaged outdoor temperature: low outdoor temperatures will result in higher desired tank temperatures as the cold water tap is colder and vice versa.

In case of **Schedule only** or **Schedule + reheat** domestic hot water preparation, the storage comfort temperature is weather-dependent (according to the weather-dependent curve), the storage economic and reheat temperature are NOT weather-dependent.

In case of **Reheat only** domestic hot water preparation, the desired tank temperature is weather-dependent (according to the weather-dependent curve). During weather-dependent operation, the end-user cannot adjust the desired tank temperature on the user interface. Also see "[10.5 Weather-dependent curve](#)" [▶ 88].

#	Code	Description
[5.C]	[0-0E] [0-0D] [0-0C] [0-0B]	<p>WD curve:</p> <p>Note: There are 2 methods to set the weather dependent curve. See "10.5.3 2-points curve" [▶ 90] and "10.5.2 Slope-offset curve" [▶ 89] for more information about the different curve types. Both curve types require 4 field settings to be configured according to the figure below.</p> <ul style="list-style-type: none"> ▪ T_{DHW}: The desired tank temperature. ▪ T_a: The (averaged) outdoor ambient temperature ▪ [0-0E]: low outdoor ambient temperature: $-40^{\circ}\text{C}\sim 5^{\circ}\text{C}$ ▪ [0-0D]: high outdoor ambient temperature: $10^{\circ}\text{C}\sim 25^{\circ}\text{C}$ ▪ [0-0C]: desired tank temperature when the outdoor temperature equals or drops below the low ambient temperature: $45^{\circ}\text{C}\sim [6-0E]^{\circ}\text{C}$ ▪ [0-0B]: desired tank temperature when the outdoor temperature equals or rises above the high ambient temperature: $35^{\circ}\text{C}\sim [6-0E]^{\circ}\text{C}$

Margin

In domestic hot water operation, the following hysteresis value can be set for the heat pump operation:

#	Code	Description
[5.D]	[6-01]	The temperature difference determining the heat pump OFF temperature. Range: $0^{\circ}\text{C}\sim 10^{\circ}\text{C}$

Example: setpoint (T_U) > maximum heat pump temperature – [6-01] ($T_{HP\ MAX} - [6-01]$)

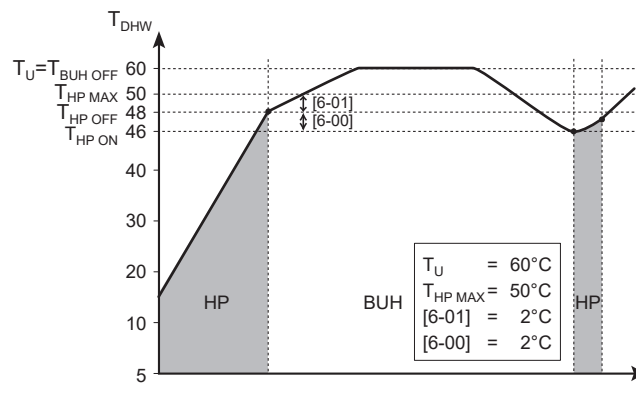

BUH Backup heater

HP Heat pump. If heating up time by the heat pump takes too long, auxiliary heating by the backup heater can take place

$T_{BUH\ OFF}$ Backup heater OFF temperature (T_U)

$T_{HP\ MAX}$ Maximum heat pump temperature at sensor in domestic hot water tank

$T_{HP\ OFF}$ Heat pump OFF temperature ($T_{HP\ MAX} - [6-01]$)

$T_{HP\ ON}$ Heat pump ON temperature ($T_{HP\ OFF} - [6-00]$)

T_{DHW} Domestic hot water temperature

T_U User setpoint temperature (as set on the user interface)

t Time

Example: setpoint (T_U) ≤ maximum heat pump temperature - [6-01] ($T_{HP\ MAX} - [6-01]$)

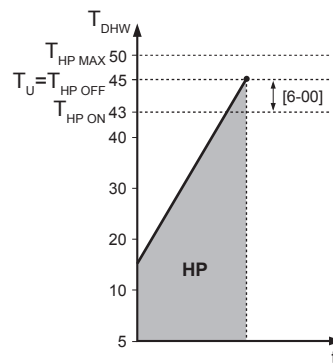

HP Heat pump. If heating up time by the heat pump takes too long, auxiliary heating by the backup heater can take place

$T_{HP\ MAX}$ Maximum heat pump temperature at sensor in domestic hot water tank

$T_{HP\ OFF}$ Heat pump OFF temperature ($T_{HP\ MAX} - [6-01]$)

$T_{HP\ ON}$ Heat pump ON temperature ($T_{HP\ OFF} - [6-00]$)

T_{DHW} Domestic hot water temperature

T_U User setpoint temperature (as set on the user interface)

t Time



INFORMATION

The maximum heat pump temperature depends on the ambient temperature. For more information, see the operation range.

WD curve type

There are 2 methods to define the weather-dependent curves:

- 2-points (see "10.5.3 2-points curve" [▶ 90])
- Slope-Offset (see "10.5.2 Slope-offset curve" [▶ 89])

In [2.E] **WD curve type**, you can choose which method you want to use.

In [5.E] **WD curve type**, the chosen method is shown read-only (same value as in [2.E]).

#	Code	Description
[2.E] / [5.E]	N/A	<ul style="list-style-type: none"> 0: 2-points 1: Slope-Offset

Priority Schedule

In case multiple indoor units (e.g. 1 Tank, 1 Air conditioning) This setting selects the operation that should be prioritized (can be set for each month) by the outdoor unit: Domestic hot water (DHW) or Air conditioning (A/C). Depending on the selected priority, the outdoor unit can either decide to handle both operation together (not possible if A/C is requesting cooling operation) or performing only one of the requested operation.

#	Code	Description
[5.F]	[A-00]	Priority schedule: <ul style="list-style-type: none"> 0: DHW 1: A/C

If DHW and A/C requests happen at the same time, the possible outcomes based on scheduled Priority settings are as follow⁽¹⁾:

If ...			The heat pump operation = ...
Which is priority?	A/C request is ...	Can outdoor unit do both? ^(a)	
DHW	Cooling	-	DHW, while A/C is put on hold
	Heating	Yes	DHW and A/C together
		No	DHW, while A/C is put on hold
A/C	Cooling	-	A/C, while DHW is by backup heater
	Heating	Yes	DHW and A/C together
		No	A/C, while DHW is by backup heater

^(a) Decided by outdoor unit.

Operation mode and Quick mode timer

During Domestic hot water (DHW) production, the backup heater allowance⁽²⁾ can be selected/limited as follows:

#	Code	Description
[5.G]	[A-01]	Priority schedule: <ul style="list-style-type: none"> 0: Efficient: Backup heater is prohibited^(a), except when outdoor unit is unable to do DHW (see Priority schedule) 1: Quick: Backup heater is allowed to assist heat pump during DHW production

⁽¹⁾ *applicable when outdoor ambient temperature and tank target temperature are within operation range of outdoor unit

⁽²⁾ When ambient temperature and/or target temperature is outside the operation range of outdoor unit, backup heater is also allowed to operate. Refer to the operation range chart of the outdoor unit for more information.

#	Code	Description
[5.H]	[8-03]	When Quick is selected, the backup heater can start to assist the heat pump operation after a delay time. The delay time depends on the selected Quick mode timer : <ul style="list-style-type: none"> ▪ Turbo (10 minutes) ▪ Normal (20 minutes) ▪ Economic (30 minutes)

^(a) When tank disinfection is performed with **Efficient** mode, the backup heater can still start after 20 minutes to assist the heat pump.

10.6.3 User settings

Overview

The following items are listed in the submenu:

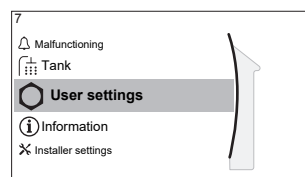

[7] User settings

[7.1] Language

[7.2] Time/date

[7.3] Holiday

[7.4] Quiet

Language

#	Code	Description
[7.1]	N/A	Language

Time/date

#	Code	Description
[7.2]	N/A	Set the local time and date



INFORMATION

By default, daylight savings time is enabled and clock format is set to 24 hours. These settings can be changed during initial configuration or via the menu structure [7.2]: **User settings > Time/date**.

Holiday

About holiday mode

During your holiday, you can use the holiday mode to deviate from your normal schedules without having to change them. While holiday mode is active, domestic hot water operation will be turned off. Disinfection operation will remain active.

Typical workflow









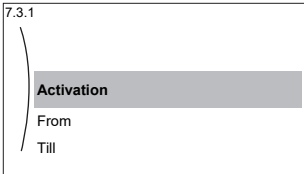

Using holiday mode typically consists of the following stages:

- 1 Activating the holiday mode.
- 2 Setting the starting date and ending date of your holiday.

To check if holiday mode is activated and/or running

If is displayed on the home screen, holiday mode is active.

To configure the holiday

1	Activate the holiday mode.	—
	<ul style="list-style-type: none"> Go to [7.3.1]: User settings > Holiday > Activation. 	
	<ul style="list-style-type: none"> Select On. 	
2	Set the first day of your holiday.	—
	<ul style="list-style-type: none"> Go to [7.3.2]: From. 	
	<ul style="list-style-type: none"> Select a date. 	 
	<ul style="list-style-type: none"> Confirm the changes. 	
3	Set the last day of your holiday.	—
	<ul style="list-style-type: none"> Go to [7.3.3]: Till. 	
	<ul style="list-style-type: none"> Select a date. 	 
	<ul style="list-style-type: none"> Confirm the changes. 	

Quiet

About quiet mode

You can use quiet mode to decrease the sound of the outdoor unit. However, this also decreases the heating/cooling capacity of the system. There are multiple quiet mode levels.

The installer can:

- Completely deactivate quiet mode
- Manually activate a quiet mode level
- Enable the user to program a quiet mode schedule
- Configure restrictions based on local regulations

If enabled by the installer, the user can program a quiet mode schedule.



INFORMATION





If the outdoor temperature is below zero, we recommend to NOT use the most quiet level.

To check if quiet mode is active



If  is displayed on the home screen, quiet mode is active.

To use quiet mode

1	Go to [7.4.1]: User settings > Quiet > Mode.	
2	Do one of the following:	—

If you want to...	Then...	
Completely deactivate quiet mode	Select Off . Result: The unit never runs in quiet mode. The user cannot change this.	
Manually activate a quiet mode level	Select Manual . Go to [7.4.3] Level and select the applicable quiet mode level. Example: Most quiet. Result: The unit always runs in the selected quiet mode level. The user cannot change this.	 
<ul style="list-style-type: none"> ▪ Enable the user to program a quiet mode schedule, AND/OR ▪ Configure restrictions based on local regulations 	Select Automatic . Result: <ul style="list-style-type: none"> ▪ The user (or you) can program the schedule in [7.4.2] Schedule. For more information about scheduling, see "10.4.3 Schedule screen: Example" [▶ 85]. ▪ You can configure restrictions in [7.4.4] Restrictions. See below. ▪ The possible outcomes for the quiet mode differ depending on the schedule (if programmed) and the restrictions (if enabled/defined). See below. 	

To configure restrictions

1	Enable the restrictions. Go to [7.4.4.1]: User settings > Quiet > Restrictions > Enable and select Yes .	
2	Define the restrictions (time + level) to be used before midday (AM): <ul style="list-style-type: none"> ▪ [7.4.4.2] AM Restricted time Example: From 9 a.m. to 11 a.m. ▪ [7.4.4.3] AM Restricted level Example: More quiet 	
3	Define the restrictions (time + level) to be used after midday (PM): <ul style="list-style-type: none"> ▪ [7.4.4.4] PM Restricted time Example: From 3 p.m. to 7 p.m. ▪ [7.4.4.5] PM Restricted level Example: Most quiet 	

Possible outcomes when quiet mode is set to Automatic

If...			Then quiet mode =...
Restrictions enabled?	Restrictions (time + level) defined?	Schedule programmed?	
No	N/A	No	OFF
		Yes	Follows schedule
Yes	No	No	OFF
		Yes	Follows schedule
	Yes	No	Follows restriction
		Yes	<ul style="list-style-type: none"> ▪ During restricted time: If restricted level is stricter than scheduled level, then follows restriction. Else, follows schedule. ▪ Outside restricted time: Follows schedule.

10.6.4 Information

Overview

The following items are listed in the submenu:

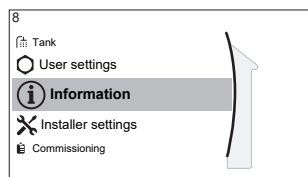

[8] Information

- [8.1] Energy data
- [8.2] Malfunction history
- [8.3] Dealer information
- [8.4] Sensors
- [8.5] Actuators
- [8.6] Operation modes
- [8.7] About
- [8.8] Connection status
- [8.9] Running hours

Dealer information

The installer can fill in his contact number here.

#	Code	Description
[8.3]	N/A	Number that users can call in case of problems.

Reset

Reset the configuration settings stored in the MMI (user interface of the indoor unit).

Example: Energy meterings, holiday settings.

INFORMATION
This does not reset the configuration settings and field settings of the indoor unit.

#	Code	Description
[8.A]	N/A	Reset the MMI EEPROM to factory default

Possible read-out information

In menu...	You can read out...
[8.1] Energy data	Produced energy and consumed electricity
[8.2] Malfunction history	Malfunction history
[8.3] Dealer information	Contact/helpdesk number
[8.4] Sensors	Room temperature, outside temperature, leaving water temperature,...
[8.5] Actuators	Status/mode of each actuator Example: Unit pump ON/OFF
[8.6] Operation modes	Current operation mode Example: Defrost/oil return mode
[8.7] About	Version information about the system
[8.8] Connection status	Information about the connection status of the unit, the room thermostat and WLAN
[8.9] Running hours	Running hours of specific system components

10.6.5 Installer settings

Overview

The following items are listed in the submenu:

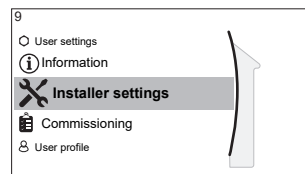

[9] Installer settings

- [9.1] Configuration wizard
- [9.3] Backup heater
- [9.5] Emergency
- [9.9] Power consumption control
- [9.E] Auto restart
- [9.F] Power saving function
- [9.G] Disable protections
- [9.I] Overview field settings
- [9.N] Export MMI settings

Configuration wizard

After first power ON of the system, the user interface will guide you using the configuration wizard. This way you can set the most important initial settings. This way the unit will be able to run properly. Afterwards, more detailed settings can be done via the menu structure if required.

To restart the configuration wizard, go to **Installer settings > Configuration wizard** [9.1].

Domestic hot water

Domestic hot water

The tank type is displayed, but cannot be adjusted.

DHW pump

#	Code	Description
[9.2.2]	[D-02]	<p>DHW pump:</p> <ul style="list-style-type: none"> ▪ 0: No DHW pump: NOT installed ▪ 1: Instant hot water: Installed for instant hot water when water is tapped. The user sets the operation timing of the domestic hot water pump using the schedule. Control of this pump is possible with the user interface. ▪ 2: Disinfection: Installed for disinfection. It runs when the disinfection function of the domestic hot water tank is running. No further settings are needed.

See also:

- ["6.2.5 DHW pump for disinfection"](#) [▶ 29]

DHW pump schedule

Program a schedule for the DHW pump (**only for field supplied domestic hot water pump for secondary return**).

Program a domestic hot water pump schedule to determine when to turn on and off the pump.

When turned on, the pump runs and makes sure hot water is instantly available at the tap. To save energy, only turn on the pump during periods of the day when instant hot water is necessary.

Backup heater

Besides the type of backup heater, the voltage, configuration and capacity must be set on the user interface.

The capacities for the different steps of the backup heater must be set for the energy metering and/or power consumption feature to work properly. When measuring the resistance value of each heater, you can set the exact heater capacity and this will lead to more accurate energy data.

Backup heater type

The backup heater is adapted to be connected to most common European electricity grids. The type of backup heater can be viewed but not changed.

#	Code	Description
[9.3.1]	[E-03]	▪ 2: 1.5V

Voltage

- For a 1.5V model, this is set to:
 - 230V, 1ph

#	Code	Description
[9.3.2]	[5-0D]	▪ 0: 230V, 1ph

Configuration

The backup heater configuration can be viewed but not changed. The backup heater will operate with 1-step only.

#	Code	Description
[9.3.3]	[4-0A]	▪ 0: 1.5 kW

Capacity step 1

#	Code	Description
[9.3.4]	[6-03]	▪ The capacity of the first step of the backup heater at nominal voltage.

Emergency

Emergency

When the heat pump fails to operate, the backup heater can serve as an emergency heater. It then takes over the heat load either automatically or by manual interaction.

- When **Emergency** is set to **Automatic** and a heat pump failure occurs, the backup heater automatically takes over the domestic hot water production.
- When **Emergency** is set to **Manual** and a heat pump failure occurs, the domestic hot water heating stops.

To manually recover it via the user interface, go to the **Malfunctioning** main menu screen and confirm whether the backup heater can take over the heat load or not.

To keep energy consumption low, we recommend to set **Emergency** to **Manual** if the house is unattended for longer periods.

#	Code	Description
[9.5.1]	[4-06]	▪ 0: Manual ▪ 1: Automatic



INFORMATION

The auto emergency setting can be set in the menu structure of the user interface only.

Compressor forced off

Compressor forced off mode can be activated to only allow the backup heater to provide domestic hot water. When this mode is activated:

- Heat pump operation is NOT possible

#	Code	Description
[9.5.2]	[7-06]	Activation of the Compressor forced off mode: ▪ 0: disabled ▪ 1: enabled

Power consumption control

Power consumption control

See "6 Application guidelines" [▶ 26] for detailed information about this functionality.

#	Code	Description
[9.9.1]	[4-08]	Power consumption control: <ul style="list-style-type: none"> ▪ 0 No: Disabled. ▪ 1 Continuous: Enabled: You can set one power limitation value (in A or kW) to which the system power consumption will be limited for all the time.
[9.9.2]	[4-09]	Type: <ul style="list-style-type: none"> ▪ 0 Amp: The limitation values are set in A. ▪ 1 kW: The limitation values are set in kW.

Limit when [9.9.1]=Continuous and [9.9.2]=Amp:

#	Code	Description
[9.9.3]	[5-05]	Limit: Only applicable in case of full time current limitation mode. 12 A~50 A

Limit when [9.9.1]=Continuous and [9.9.2]=kW:

#	Code	Description
[9.9.8]	[5-09]	Limit: Only applicable in case of full time power limitation mode. 3 kW~20 kW

Energy metering

Energy metering

If energy metering is performed by the use of external power meters, configure the settings as described below. Select the pulse frequency output of each power meter in accordance with the power meter specifications. It is possible to connect up to 2 power meters with different pulse frequencies. If only 1 or no power meter is used, select 'None' to indicate the corresponding pulse input is NOT used.

#	Code	Description
[9.A.1]	[D-08]	Electricity meter 1: <ul style="list-style-type: none"> ▪ 0 None: NOT installed ▪ 1 1/10kWh: Installed ▪ 2 1/kWh: Installed ▪ 3 10/kWh: Installed ▪ 4 100/kWh: Installed ▪ 5 1000/kWh: Installed

#	Code	Description
[9.A.2]	[D-09]	<p>Electricity meter 2:</p> <ul style="list-style-type: none"> ▪ 0 None: NOT installed ▪ 1 1/10kWh: Installed ▪ 2 1/kWh: Installed ▪ 3 10/kWh: Installed ▪ 4 100/kWh: Installed ▪ 5 1000/kWh: Installed <p>In case of pulse meter for photovoltaic panels:</p> <ul style="list-style-type: none"> ▪ 6 100/kWh for PV panel: Installed ▪ 7 1000/kWh for PV panel: Installed

Sensors

Averaging time

The average timer corrects the influence of ambient temperature variations. The weather-dependent setpoint calculation is done on the average outdoor temperature.

The outdoor temperature is averaged over the selected time period.

#	Code	Description
[9.B.3]	[1-0A]	<p>Averaging time:</p> <ul style="list-style-type: none"> ▪ 0: No averaging ▪ 1: 12 hours ▪ 2: 24 hours ▪ 3: 48 hours ▪ 4: 72 hours

Auto restart

Auto restart

When power returns after a power supply failure, the auto restart function reapplies the user interface settings at the time of the power failure. Therefore, it is recommended to always enable the function.

#	Code	Description
[9.E]	[3-00]	<p>Auto restart:</p> <ul style="list-style-type: none"> ▪ 0: Manual ▪ 1: Automatic

Power saving function

Power saving function

Defines whether the outdoor unit power supply can be interrupted (internally by indoor unit control) during stand-still conditions (no domestic hot water demand). The final decision to allow power interruption of the outdoor unit during standstill depends on the ambient temperature, compressor conditions and minimum internal timers.

To enable the power saving function setting, [E-08] needs to be enabled on the user interface.

#	Code	Description
[9.F]	[E-08]	Power saving function for outdoor unit: <ul style="list-style-type: none"> ▪ 0: No ▪ 1: Yes

**INFORMATION**

Refer to the installer reference guide of the 5MWXM outdoor unit for details about the power saving function.

Disable protections**Protective functions**

The unit is equipped with the following protective function:

- Tank disinfection [2-01]

#	Code	Description
[9.G]	N/A	Disable protections: <ul style="list-style-type: none"> ▪ 0: No ▪ 1: Yes

Overview field settings

Almost all settings can be done using the menu structure. If for any reason it is required to change a setting using the overview settings, then the overview settings can be accessed in the field settings overview [9.I]. See "[To modify an overview setting](#)" [▶ 76].

Export MMI settings**About exporting the configuration settings**

Export the configuration settings of the unit to a USB memory stick, via the MMI (the user interface of the indoor unit). When troubleshooting, these settings can be provided to our Service department.

#	Code	Description
[9.N]	N/A	Your MMI settings will be exported to the connected storage device: <ul style="list-style-type: none"> ▪ Back ▪ OK

To export MMI settings

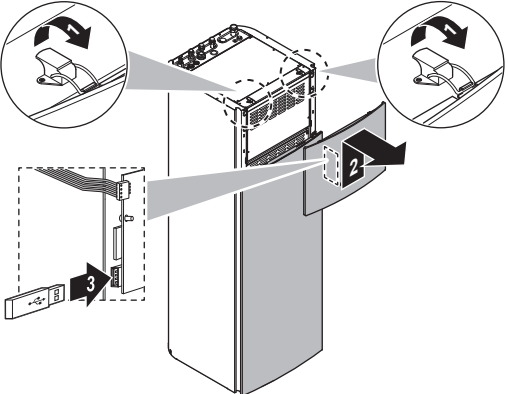
1	Open the user interface panel and insert a USB memory stick.	—
		
2	On the user interface, go to [9.N] Export MMI settings.	⏪⏩⦿
3	Select OK.	⏪⏩⦿
4	Remove the USB memory stick and close the user interface panel.	—

10.6.6 Commissioning

Overview

The following items are listed in the submenu:

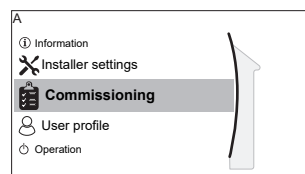

[A] Commissioning

[A.1] Operation test run

[A.2] Actuator test run

[A.3] Air purge

About commissioning

See: "[11 Commissioning](#)" [▶ 117]

10.6.7 User profile

[B] User profile: See "[To change the user permission level](#)" [▶ 75].

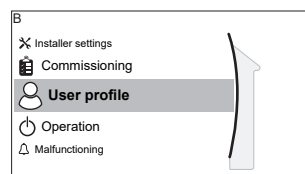

[B] User profile

10.6.8 Operation

Overview

The following items are listed in the submenu:

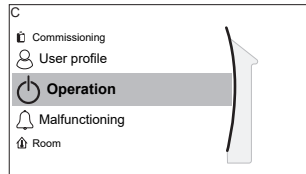

[C] Operation

[C.3] Tank

To enable or disable functionalities

In the operation menu, you can separately enable or disable functionalities of the unit.

#	Code	Description
[C.3]	N/A	Tank: <ul style="list-style-type: none"> ▪ 0: Off ▪ 1: On

10.6.9 WLAN



INFORMATION

Restriction: WLAN settings are only visible when a WLAN cartridge is inserted in the user interface.

Overview

The following items are listed in the submenu:

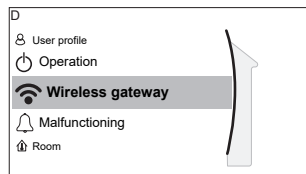

[D] Wireless gateway

[D.1] Enable AP mode

[D.2] Reboot

[D.3] WPS

[D.4] Remove from cloud

[D.5] Home network connection

[D.6] Cloud connection

About the WLAN cartridge

The WLAN cartridge connects the system to the internet. The user can then control the system via the ONECTA app.

This needs the following components:

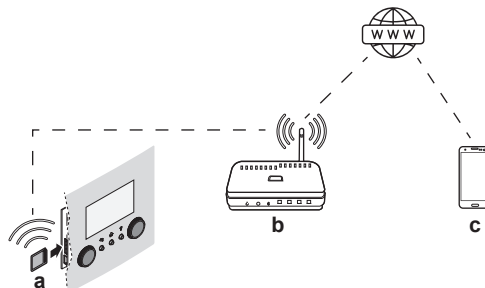



a	WLAN cartridge	The WLAN cartridge needs to be inserted in the user interface. See the installation manual of the WLAN cartridge.
b	Router	Field supply.

c	Smartphone + app 	The ONECTA app needs to be installed on the user's smartphone. See: http://www.onlinecontroller.daikineurope.com/ 
---	---	---

Configuration

To configure the ONECTA app, follow the in-app instructions. While doing this, the following actions and information ([D.1]~[D.6]) are needed on the user interface:

[D.1] **Enable AP mode:** Make the WLAN cartridge active as access point.

#	Code	Description
[D.1]	N/A	<p>This setting generates a random SSID and key (+ QR code) needed by the ONECTA app:</p> <div data-bbox="906 734 1433 1048" style="border: 1px solid black; padding: 5px;"> <p>D.1 AP mode enabled</p>  <p>SSID DaikinAPXXXXX</p> <p>Key XYZ12345</p> </div> <p>This screen exits automatically after 10 min, or when you press  or  (and confirm):</p> <div data-bbox="906 1149 1433 1456" style="border: 1px solid black; padding: 5px;"> <p>Are you sure you want to exit AP mode?</p> <p>Back</p> <p>OK </p> </div>

[D.2] **Reboot:** Reboot the WLAN cartridge.

#	Code	Description
[D.2]	N/A	Reboot the gateway: <ul style="list-style-type: none"> ▪ Back ▪ OK

[D.3] **WPS:** Connect the WLAN cartridge to the router.

#	Code	Description
[D.3]	N/A	WPS: <ul style="list-style-type: none"> ▪ No ▪ Yes

**INFORMATION**

You can only use this function if it is supported by the software version of the WLAN, and the software version of the ONECTA app.

[D.4] **Remove from cloud:** Remove the WLAN cartridge from the cloud.

#	Code	Description
[D.4]	N/A	Remove from cloud: <ul style="list-style-type: none"> ▪ No ▪ Yes

[D.5] **Home network connection:** Read out the status of the connection to the home network.

#	Code	Description
[D.5]	N/A	Home network connection: <ul style="list-style-type: none"> ▪ Disconnected from [WLAN_SSID] ▪ Connected to [WLAN_SSID]

[D.6] **Cloud connection:** Read out the status of the connection to the cloud.

#	Code	Description
[D.6]	N/A	Cloud connection: <ul style="list-style-type: none"> ▪ Not connected ▪ Connected

10.7 Menu structure: Overview user settings

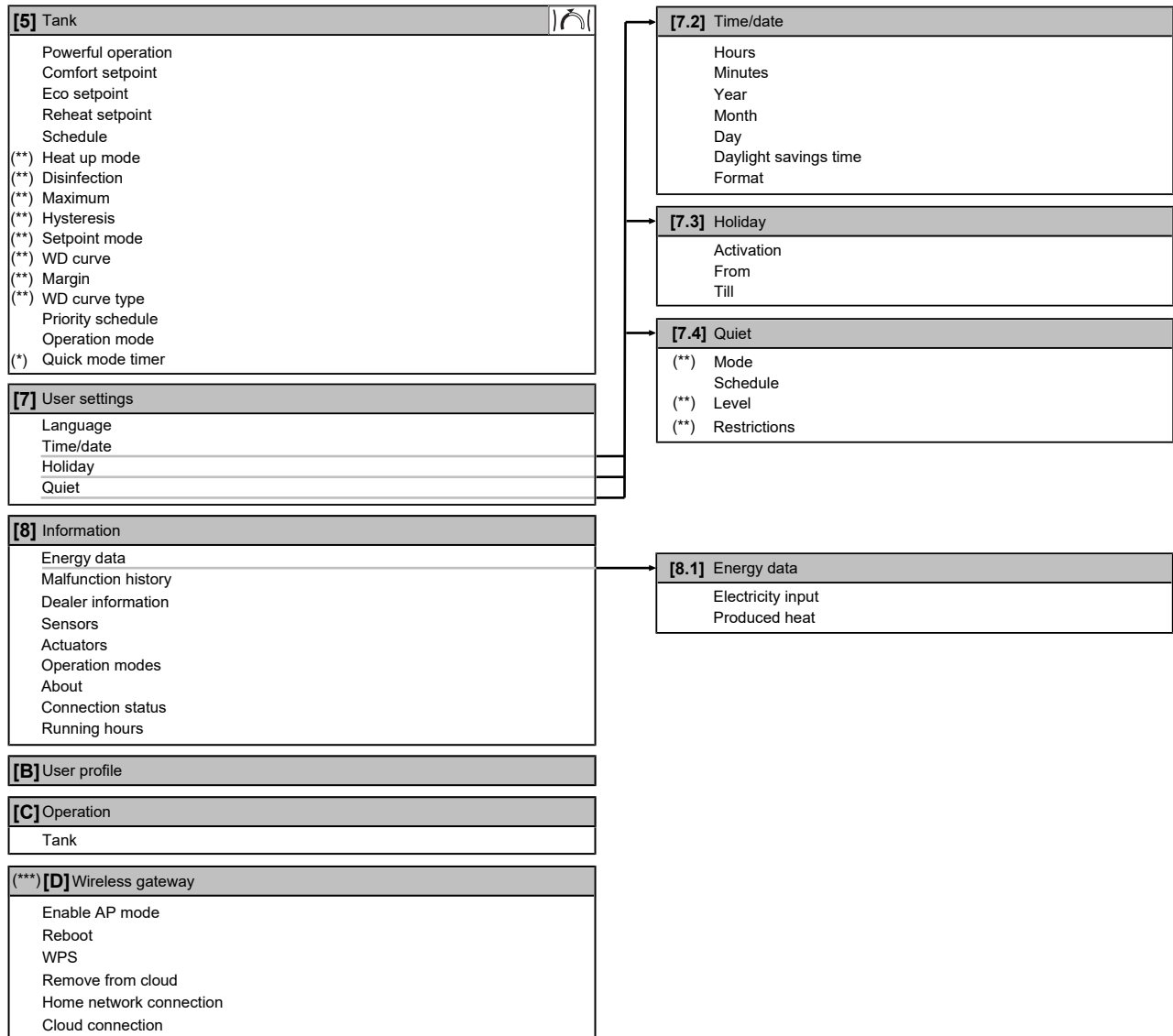

Setpoint screen

(*) Only applicable when the tank Operation Mode is Quick

(**) Only accessible by installer

(***) Only applicable when WLAN is installed



INFORMATION

Depending on the selected installer settings and unit type, settings will be visible/invisible.

10.8 Menu structure: Overview installer settings

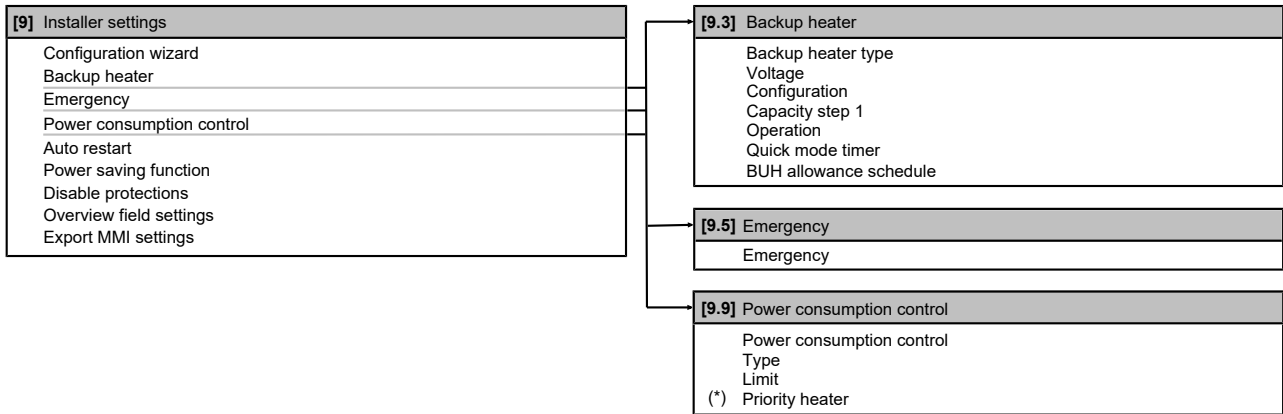

(*) Can NOT be adjusted



INFORMATION

Depending on the selected installer settings and unit type, settings will be visible/invisible.

11 Commissioning



NOTICE

General commissioning checklist. Next to the commissioning instructions in this chapter, a general commissioning checklist is also available on the Daikin Business Portal (authentication required).

The general commissioning checklist is complementary to the instructions in this chapter and can be used as a guideline and reporting template during commissioning and hand-over to the user.



NOTICE



Make sure the air purge valve on the backup heater is open. This valve must remain open after commissioning.



NOTICE

Pump. To prevent blocking of the pump rotor, commission the unit as quickly as possible after filling the water circuit.



INFORMATION

Protective functions – "Installer-on-site mode". The software is equipped with protective functions, such as Legionella disinfection function. The unit automatically runs this function according to its scheduled time.

- **At first power-on:** The protective functions are disabled by default. After 12 hours they will be automatically enabled.
- **Afterwards:** An installer can manually disable the protective functions by setting [9.G]: **Disable protections** = **Yes**. After his work is done, he can enable the protective functions by stating [9.G]: **Disable protections** = **No**.

Also see "[Protective functions](#)" [▶ 110].



INFORMATION

In the case of an outdoor unit and tank-only connection, the backup heater may be used instead of the heat pump during cold outdoor conditions. This can occur within the first 7 hours after the power supply is turned on to ensure reliable compressor operation.

In this chapter

11.1	Overview: Commissioning	117
11.2	Precautions when commissioning.....	118
11.3	Checklist before commissioning.....	118
11.4	Checklist during commissioning	119
11.4.1	Minimum flow rate	119
11.4.2	Air purge function	120
11.4.3	Operation test run	121
11.4.4	Actuator test run.....	122

11.1 Overview: Commissioning

This chapter describes what you have to do and know to commission the system after it is installed and configured.

Typical workflow

Commissioning typically consists of the following stages:

- 1 Checking the "Checklist before commissioning".
- 2 Performing a test run for the system.
- 3 If necessary, performing a test run for one or more actuators.

11.2 Precautions when commissioning

**NOTICE**

ALWAYS operate the unit with thermistors and/or pressure sensors/switches. If NOT, burning of the compressor might be the result.

**NOTICE**

ALWAYS complete the refrigerant piping of the unit before operating. If NOT, the compressor will break.

**INFORMATION**

During the first running period of the unit, the required power may be higher than stated on the nameplate of the unit. This phenomenon is caused by the compressor, that needs a continuous run time of 50 hours before reaching smooth operation and stable power consumption.

**INFORMATION**

In the case of an outdoor unit and tank-only connection, the backup heater may be used instead of the heat pump during cold outdoor conditions. This can occur within the first 7 hours after the power supply is turned on to ensure reliable compressor operation.

11.3 Checklist before commissioning

- 1 After the installation of the unit, ensure that the user interface (MMI) software is version 7.7.0 or higher. If not, upgrade it and check the items listed below.
- 2 Close the unit.
- 3 Power up the unit.

<input type="checkbox"/>	You read the complete installation instructions, as described in the installer reference guide .
<input type="checkbox"/>	The indoor unit is properly mounted.
<input type="checkbox"/>	The outdoor unit is properly mounted.
<input type="checkbox"/>	The following field wiring has been carried out according to this document and the applicable legislation: <ul style="list-style-type: none"> ▪ Between the local supply panel and the outdoor unit ▪ Between indoor unit and outdoor unit ▪ Between the local supply panel and the indoor unit ▪ Between the indoor unit and the valves (if applicable)
<input type="checkbox"/>	The system is properly earthed and the earth terminals are tightened.
<input type="checkbox"/>	The fuses or locally installed protection devices are installed according to this document, and have NOT been bypassed.

<input type="checkbox"/>	The power supply voltage matches the voltage on the identification label of the unit.
<input type="checkbox"/>	There are NO loose connections or damaged electrical components in the switch box.
<input type="checkbox"/>	There are NO damaged components or squeezed pipes on the inside of the indoor and outdoor units.
<input type="checkbox"/>	Backup heater circuit breaker F1B (field supply) is turned ON.
<input type="checkbox"/>	There are NO refrigerant leaks .
<input type="checkbox"/>	The refrigerant pipes (gas and liquid) are thermally insulated.
<input type="checkbox"/>	The correct pipe size is installed and the pipes are properly insulated.
<input type="checkbox"/>	There is NO water leak inside the indoor unit.
<input type="checkbox"/>	The stop valves (gas and liquid) on the outdoor unit are fully open.
<input type="checkbox"/>	The air purge valve is open (at least 2 turns).
<input type="checkbox"/>	The pressure relief valve (DHW tank circuit) purges water when opened. Clean water MUST come out.
<input type="checkbox"/>	The minimum water volume is guaranteed in all conditions. See "To check the water volume and flow rate" in " 8.5 Preparing water piping " [▶ 55].
<input type="checkbox"/>	The domestic hot water tank is filled completely.

11.4 Checklist during commissioning

<input type="checkbox"/>	To perform an air purge .
<input type="checkbox"/>	To check that the minimum flow rate during backup heater/defrost operation is guaranteed in all conditions. See "To check the water volume and flow rate" in " 8.5 Preparing water piping " [▶ 55].
<input type="checkbox"/>	To perform a test run .
<input type="checkbox"/>	To perform an actuator test run .

11.4.1 Minimum flow rate

Purpose

For a correct operating unit, it is important to check if the minimum flow rate is reached.

1	Make sure that the water circuit and the water tank volume is filled in with water.	—
2	Start the pump test run (see " 11.4.4 Actuator test run " [▶ 122]).	—
3	Read out the flow rate ^(a) to reach the minimum required flow rate + 2 l/min.	—

^(a) During pump test run, the unit can operate below the minimum required flow rate.

If operation is...	Then the minimum required flow rate is...
Domestic hot water production/defrost	22 l/min

11.4.2 Air purge function

Purpose

When commissioning and installing the unit, it is very important to remove all air in the water circuit. When the air purge function is running, the pump operates without actual operation of the unit and the removal of air in the water circuit will start.

 **NOTICE**
 Before starting the air purge, open the safety valve and check if the circuit is sufficiently filled with water. Only if water escapes the valve after opening it, you can start the air purge procedure.

Manual or automatic

There are 2 modes for purging air:

- Manual: You can set the pump speed to low or high. You can set the circuit (the position of the 3-way valve) to Tank. Air purge must be performed for tank (domestic hot water) circuits.
- Automatic: The unit automatically changes the pump speed of the domestic hot water circuit.

Typical workflow

Purging the air from the system should consist of:

- 1 Performing a manual air purge
- 2 Performing an automatic air purge





 **INFORMATION**
 Start by performing a manual air purge. When almost all the air is removed, perform an automatic air purge. If necessary, repeat performing the automatic air purge until you are sure that all air is removed from the system. During air purge function, pump speed limitation [9-0D] is NOT applicable.







The air purge function automatically stops after 30 minutes.

 **INFORMATION**
 For best results, air purge each loop separately.

To perform a manual air purge







Conditions: Make sure all operation is disabled. Go to [C]: **Operation** and turn off Tank operation.

1	Set the user permission level to Installer . See " To change the user permission level " [▶ 75].	—
2	Go to [A.3]: Commissioning > Air purge .	
3	In the menu, set Type = Manual .	
4	Select Start air purge .	
5	Select OK to confirm.	
Result: The air purge starts. It stops automatically when ready.		

6	During manual operation:	
	<ul style="list-style-type: none"> You can change the pump speed. You must change the circuit. <p>To change these settings during the air purge, open the menu and go to [A.3.1.5]: Settings.</p>	
	<ul style="list-style-type: none"> Scroll to Circuit and set it to Tank. 	 
	<ul style="list-style-type: none"> Scroll to Pump speed and set it to Low/High. 	 
7	To stop the air purge manually:	—
1	Open the menu and go to Stop air purge .	
2	Select OK to confirm.	

To perform an automatic air purge

Conditions: Make sure all operation is disabled. Go to [C]: **Operation** and turn off Tank operation.

1	Set the user permission level to Installer . See " To change the user permission level " [▶ 75].	—
2	Go to [A.3]: Commissioning > Air purge .	
3	In the menu, set Type = Automatic .	
4	Select Start air purge .	
5	Select OK to confirm. Result: The air purge starts. It stops automatically when done.	
6	To stop the air purge manually:	—
1	In the menu, go to Stop air purge .	
2	Select OK to confirm.	

11.4.3 Operation test run

Purpose

Perform test runs on the unit and monitor the tank temperature to check if the unit is working correctly. The following test run should be made:

- Tank



To perform an operation test run





Conditions: Make sure all operation is disabled. Go to [C]: **Operation** and turn off Tank operation.

To monitor tank temperatures

During test run, the correct operation of the unit can be checked by monitoring its tank temperature (domestic hot water mode).

To monitor the temperatures:

1	In the menu, go to Sensors .	
2	Select the temperature information.	

1	Set the user permission level to Installer . See " To change the user permission level " [▶ 75].	—
2	Go to [A.1]: Commissioning > Operation test run .	
3	Select the Tank .	
4	Select OK to confirm. Result: The test run starts. It stops automatically when ready (±30 min).	
To stop the test run manually:		—
1	In the menu, go to Stop test run .	
2	Select OK to confirm.	

**INFORMATION**

If the outdoor temperature is outside the range of operation, the unit may NOT operate or may NOT deliver the required capacity.

**INFORMATION**

Under specific conditions, the compressor may remain OFF to ensure oil reliability in case the AC unit is not connected.





11.4.4 Actuator test run

Purpose

Perform an actuator test run to confirm the operation of the different actuators. For example, when you select **Pump**, a test run of the pump will start.

To perform an actuator test run

Conditions: Make sure all operation is disabled. Go to [C]: **Operation** and turn off **Tank** operation.

1	Set the user permission level to Installer . See " To change the user permission level " [▶ 75].	—
2	Go to [A.2]: Commissioning > Actuator test run .	
3	Select a test from the list. Example: Pump .	
4	Select OK to confirm. Result: The actuator test run starts. It stops automatically when ready (±30 min).	
To stop the test run manually:		—
1	In the menu, go to Stop test run .	
2	Select OK to confirm.	

Possible actuator test runs

- Backup heater 1 test
- Pump test

**INFORMATION**

Make sure that all air is purged before executing the test run. Also avoid disturbances in the water circuit during the test run.

12 Hand-over to the user

Once the test run is finished and the unit operates properly, make sure the following is clear for the user:

- Fill in the installer setting table (in the operation manual) with the actual settings.
- Make sure that the user has the printed documentation and ask him/her to keep it for future reference. Inform the user that he/she can find the complete documentation at the URL mentioned earlier in this manual.
- Explain to the user how to properly operate the system and what to do in case of problems.
- Show the user what to do for the maintenance of the unit.
- Explain about energy saving tips to the user as described in the operation manual.

13 Maintenance and service



NOTICE

General maintenance/inspection checklist. Next to the maintenance instructions in this chapter, a general maintenance/inspection checklist is also available on the Daikin Business Portal (authentication required).

The general maintenance/inspection checklist is complementary to the instructions in this chapter and can be used as a guideline and reporting template during maintenance.



NOTICE

Maintenance **MUST** be done by an authorised installer or service agent.

We recommend performing maintenance at least once a year. However, applicable legislation might require shorter maintenance intervals.



NOTICE

Applicable legislation on **fluorinated greenhouse gases** requires that the refrigerant charge of the unit is indicated both in weight and CO₂ equivalent.

Formula to calculate the quantity in CO₂ equivalent tonnes: GWP value of the refrigerant × total refrigerant charge [in kg] / 1000

In this chapter

13.1	Maintenance safety precautions.....	124
13.2	Yearly maintenance	124
13.2.1	Yearly maintenance indoor unit: overview	124
13.2.2	Yearly maintenance indoor unit: instructions	125
13.3	To drain the domestic hot water tank	127
13.4	To inspect the inside of the domestic hot water tank.....	128

13.1 Maintenance safety precautions



DANGER: RISK OF ELECTROCUTION



DANGER: RISK OF BURNING/SCALDING



NOTICE: Risk of electrostatic discharge

Before performing any maintenance or service work, touch a metal part of the unit in order to eliminate static electricity and to protect the PCB.

13.2 Yearly maintenance

13.2.1 Yearly maintenance indoor unit: overview

- Water pressure
- Water pressure relief valve
- Relief valve hose
- Pressure relief valve of the domestic hot water tank

- Switch box
- Descaling
- Chemical disinfection
- Pressure reducing valve of the domestic hot water tank kit
- Temperature and pressure relief valve

13.2.2 Yearly maintenance indoor unit: instructions

Water pressure

Keep water pressure above 1 bar. If it is lower, add water.

Water pressure relief valve

Open the valve and check if it operates correctly. **The water may be very hot!**

Checkpoints are:

- The water flow coming from the relief valve is high enough, no blockage of the valve or in between piping is suspected.
- Dirty water coming out of the relief valve:
 - open the valve until the discharged water does NOT contain dirt anymore
 - flush the system

To make sure this water originates from the tank, check after a tank heat up cycle. It is recommended to do this maintenance more frequently.

Pressure relief valve hose

Check whether the pressure relief valve hose is positioned appropriately to drain the water. See "[7.3.3 To connect the drain hose to the drain](#)" [▶ 47].

Pressure relief valve of the domestic hot water tank

Open the valve.



CAUTION

Water coming out of the valve may be very hot.

- Check if nothing blocks the water in the valve or in between piping. The water flow coming from the relief valve must be high enough.
- Check if the water coming out of the relief valve is clean. If it contains debris or dirt:
 - Open the valve until the discharged water does not contain debris or dirt anymore.
 - Flush and clean the complete tank, including the piping between the relief valve and cold water inlet.

To make sure this water originates from the tank, check after a tank heat up cycle.



INFORMATION

It is recommended to perform this maintenance more than once a year.

Switch box

- Carry out a thorough visual inspection of the switch box and look for obvious defects such as loose connections or defective wiring.

- Using an ohmmeter, check if contactors K1M, K2M, K3M and K5M (depending on your installation) operate correctly. All contacts of these contactors must be in open position when the power is turned OFF.

**WARNING**

If the internal wiring is damaged, it has to be replaced by the manufacturer, its service agent or similarly qualified persons.

Descaling

Depending on water quality and set temperature, scale can deposit on the heat exchanger inside the domestic hot water tank and can restrict heat transfer. For this reason, descaling of the heat exchanger may be required at certain intervals.

Chemical disinfection

If the applicable legislation requires a chemical disinfection in specific situations, involving the domestic hot water tank, please be aware that the domestic hot water tank is a stainless steel cylinder. We recommend to use a non-chloride based disinfectant approved for use with water intended for human consumption.

**NOTICE**

When using means for descaling or chemical disinfection, make sure water quality still complies with EU directive 2020/2184.

Pressure reducing valve

Depending on local water conditions, annual inspection of the integral line strainer, pressure reducing valve cartridge and seating may be necessary.

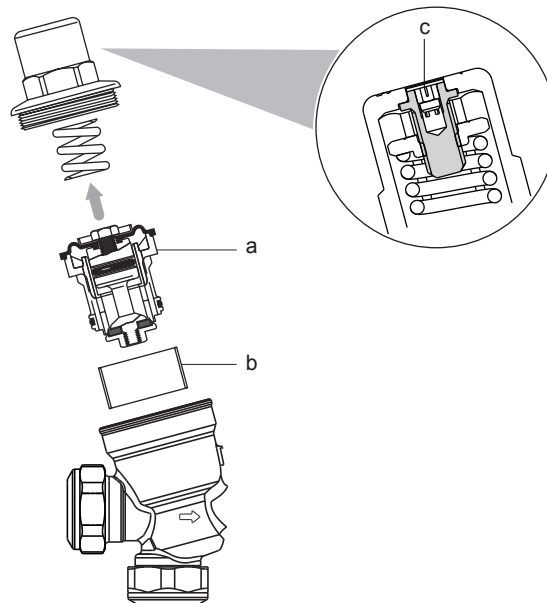

- a Cartridge
- b Strainer
- c Calibration screw

- Unscrew the plastic cover of the pressure reducing valve.
- Extract the cartridge with the aid of long nosed pliers to grip the head of the set screw.
- Remove the strainer element.
- Clean the strainer element and cartridge under clean running water.
- Replace if the strainer or cartridge are damaged.

- 6 Refit the strainer, cartridge and cover.
- 7 If the cartridge has been replaced, calibrate the pressure reducing valve:
 - Close the downstream isolating valve (field supply).
 - Install an Allen key on the calibration screw in the centre of the plastic cover. Rotate it clockwise to increase the outlet pressure and anticlockwise to reduce it.

Temperature and pressure relief valve

Check for correct operation of the temperature and pressure relief valve. Manually operate the temperature and pressure relief valve to ensure free water flow through discharge pipe. Turn knob left.

13.3 To drain the domestic hot water tank



DANGER: RISK OF BURNING/SCALDING

The water in the tank can be very hot.

Prerequisite: Stop the unit operation via the user interface.

Prerequisite: Turn OFF the respective circuit breaker.

Prerequisite: Close the cold water supply.

Prerequisite: Open all the hot water tapping points to allow air to enter the system.

- 1 Remove the top panel. See "[7.2.2 To open the indoor unit](#)" [▶ 44].
- 2 Remove the user interface panel. See "[7.2.2 To open the indoor unit](#)" [▶ 44].
- 3 Lower the switchbox. See "[7.2.3 To lower the switch box](#)" [▶ 46].
- 4 Remove the tube from the temperature and pressure relief valve that is located on top of the tank.
- 5 Remove the temperature and pressure relief valve from the tank.
- 6 Use a drain hose and a pump to drain the tank via the access point.

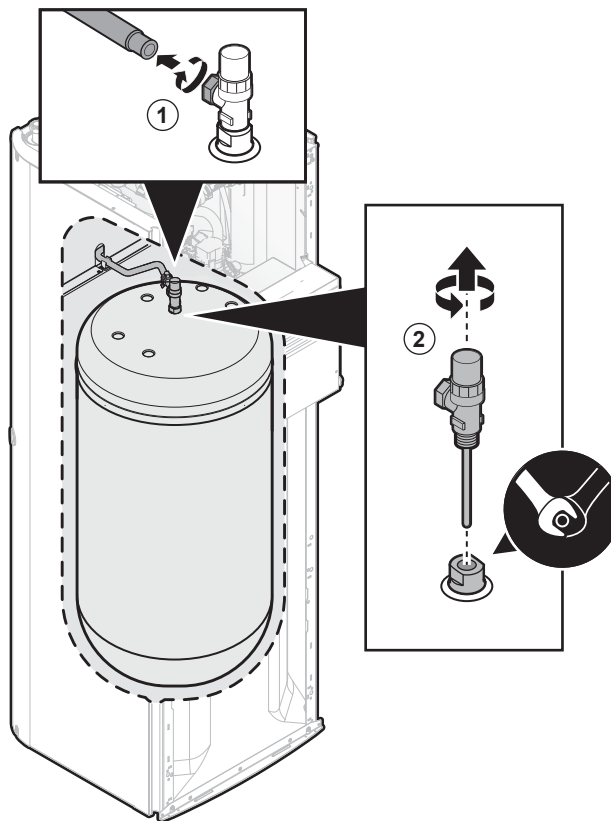

7 Tightening torques for installation:

Item	Tightening torque
Tube connection	30 N•m
Temperature and pressure relief valve	40 N•m

13.4 To inspect the inside of the domestic hot water tank



DANGER: RISK OF BURNING/SCALDING

The water in the tank can be very hot.

Prerequisite: Stop the unit operation via the user interface.

Prerequisite: Turn OFF the respective circuit breaker.

Prerequisite: Close the cold water supply.

Prerequisite: Open all the hot water tapping points to allow air to enter the system.

Prerequisite: Remove the top panel. See "[7.2.2 To open the indoor unit](#)" [▶ 44].

- 1 Remove the clip that fixes the domestic hot water OUT pipe.
- 2 Disconnect the pipe such that the tank is accessible for visual inspection (e.g. with an endoscope).

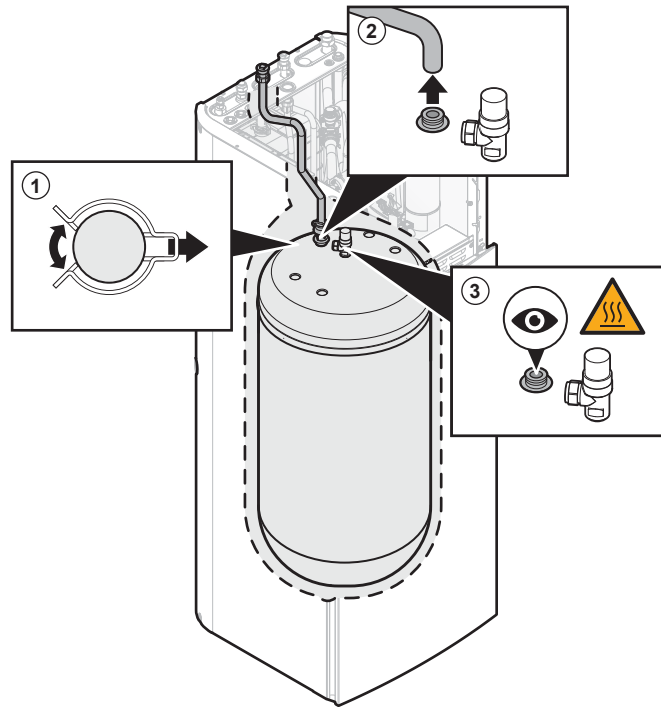

- 3** Reconnect the pipe to the tank.
- 4** Reinstall the clip to fix the domestic hot water OUT pipe.

14 Troubleshooting

In this chapter

14.1	Overview: Troubleshooting	130
14.2	Precautions when troubleshooting	130
14.3	Solving problems based on symptoms	131
14.3.1	Symptom: Hot water does NOT reach the desired temperature	131
14.3.2	Symptom: The compressor does NOT start	131
14.3.3	Symptom: The system is making gurgling noises after commissioning	131
14.3.4	Symptom: The pump is blocked	132
14.3.5	Symptom: The pump is making noise (cavitation)	132
14.3.6	Symptom: The pressure relief valve opens	133
14.3.7	Symptom: The water pressure relief valve leaks	133
14.3.8	Symptom: The pressure at the tapping point is temporarily unusually high	133
14.3.9	Symptom: Tank disinfection function is NOT completed correctly (AH-error)	133
14.4	Solving problems based on error codes	134
14.4.1	To display the help text in case of a malfunction	134
14.4.2	Error codes: Overview	135

14.1 Overview: Troubleshooting

This chapter describes what you have to do in case of problems.

It contains information about:

- Solving problems based on symptoms
- Solving problems based on error codes

Before troubleshooting

Carry out a thorough visual inspection of the unit and look for obvious defects such as loose connections or defective wiring.

14.2 Precautions when troubleshooting



DANGER: RISK OF ELECTROCUTION



DANGER: RISK OF BURNING/SCALDING



WARNING

- When carrying out an inspection on the switch box of the unit, ALWAYS make sure that the unit is disconnected from the mains. Turn off the respective circuit breaker.
- When a safety device was activated, stop the unit and find out why the safety device was activated before resetting it. NEVER shunt safety devices or change their values to a value other than the factory default setting. If you are unable to find the cause of the problem, call your dealer.



WARNING

Prevent hazards due to inadvertent resetting of the thermal cut-out: power to this appliance MUST NOT be supplied through an external switching device, such as a timer, or connected to a circuit that is regularly turned ON and OFF by the utility.

14.3 Solving problems based on symptoms



14.3.1 Symptom: Hot water does NOT reach the desired temperature

Possible causes	Corrective action
One of the tank temperature sensors is broken.	See the service manual of the unit for the corresponding corrective action.

14.3.2 Symptom: The compressor does NOT start

Possible causes	Corrective action
The compressor cannot start if the water temperature is too low. The unit will use the backup heater to reach the minimum water temperature (10°C), after which the compressor can start.	<p>If the backup heater doesn't start either, check and make sure that:</p> <ul style="list-style-type: none"> ▪ The power supply to the backup heater is correctly wired. ▪ The backup heater thermal protector is NOT activated. ▪ The backup heater contactors are NOT broken. <p>If the problem persists, contact your dealer.</p>
Domestic hot water (including disinfection) and A/C heating/cooling are scheduled to start at the same time.	Change the schedule to not start both operation modes at the same moment.



14.3.3 Symptom: The system is making gurgling noises after commissioning

Possible cause	Corrective action
There is air in the system.	Purge air from the system. ^(a)
Incorrect hydraulic balance.	To be performed by the installer: <ul style="list-style-type: none"> ▪ If hydraulic balancing is not sufficient, change the pump limitation settings ([9-0D] and [9-0E] if applicable).
Various malfunctions.	Check if  or  is displayed on the home screen of the user interface. See "14.4.1 To display the help text in case of a malfunction" [▶ 134] for more information about the malfunction.

^(a) We recommend to purge air with the air purge function of the unit (to be performed by the installer). If you purge air from the heating circuit, mind the following:



WARNING

Air purging heating circuit for domestic hot water. Before you purge air, check if  or  is displayed on the home screen of the user interface.

- If not, you can purge air immediately.
- If yes, make sure that the room where you want to purge air is sufficiently ventilated. **Reason:** In case of a breakdown, refrigerant might leak into the water circuit, and subsequently into the room when you purge air from the heating circuit of the domestic hot water.

14.3.4 Symptom: The pump is blocked

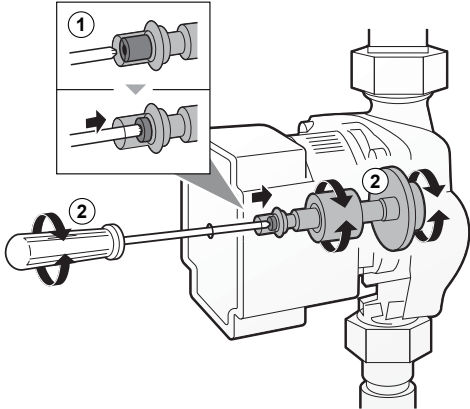
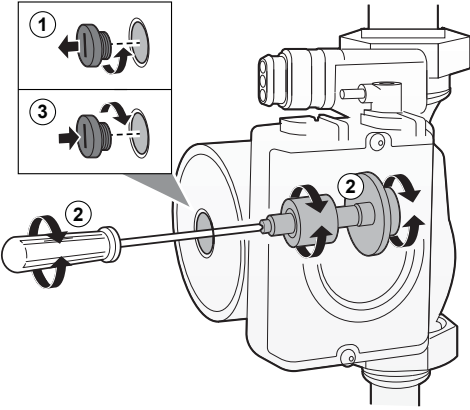
Possible causes	Corrective action
<p>If the unit has been powered off for a long time, lime might block the rotor of the pump.</p>	<p>Depending on the pump type, do one of the following:</p> <ul style="list-style-type: none"> Use a Philips No. 2 screwdriver to push the deblocking screw of the rotor in (0.5 cm). Then turn the deblocking screw back and forth until the rotor is deblocked.^(a) <p>Note: Do NOT use excessive force.</p>  <ul style="list-style-type: none"> Remove the screw of the stator housing and use a screwdriver to turn back and forth the ceramic shaft of the rotor until the rotor is deblocked.^(a) <p>Note: Do NOT use excessive force.</p> 

^(a) If you cannot deblock the rotor of the pump with this method, you will need to disassemble the pump and turn the rotor by hand.

14.3.5 Symptom: The pump is making noise (cavitation)

Possible causes	Corrective action
<p>There is air in the system</p>	<p>Purge air manually (see "To perform a manual air purge" [▶ 120]) or use the automatic air purge function (see "To perform an automatic air purge" [▶ 121]).</p>

Possible causes	Corrective action
The water pressure at the pump inlet is too low	Check and make sure that: <ul style="list-style-type: none"> ▪ The water pressure is >1 bar. ▪ The water pressure sensor is NOT broken. ▪ The expansion vessel is NOT broken. ▪ The pre-pressure setting of the expansion vessel is correct (see "8.5.4 Changing the pre-pressure of the expansion vessel" [▶ 59]).

14.3.6 Symptom: The pressure relief valve opens

Possible causes	Corrective action
The expansion vessel is broken	Replace the expansion vessel.

14.3.7 Symptom: The water pressure relief valve leaks

Possible causes	Corrective action
Dirt is blocking the water pressure relief valve outlet	Check whether the pressure relief valve works correctly by turning the red knob on the valve counterclockwise: <ul style="list-style-type: none"> ▪ If you do NOT hear a clacking sound, contact your dealer. ▪ If the water keeps running out of the unit, close both the water inlet and outlet shut-off valves first and then contact your dealer.

14.3.8 Symptom: The pressure at the tapping point is temporarily unusually high

Possible causes	Corrective action
Failing or blocked pressure relief valve.	<ul style="list-style-type: none"> ▪ Flush and clean the complete tank including the piping between pressure relief valve and the cold water inlet. ▪ Replace the pressure relief valve.

14.3.9 Symptom: Tank disinfection function is NOT completed correctly (AH-error)

Possible causes	Corrective action
The disinfection function was interrupted by domestic hot water tapping	Program the start-up of the disinfection function when the coming 4 hours NO domestic hot water tapping is expected.

Possible causes	Corrective action
Large domestic hot water tapping happened recently before the programmed start-up of the disinfection function	<p>If in [5.6] Tank > Heat up mode the mode Reheat only or Schedule + reheat is selected, it is recommended to program the start-up of the disinfection function at least 4 hours later than the last expected large hot water tapping. This start-up can be set by installer settings (disinfection function).</p> <p>If in [5.6] Tank > Heat up mode the mode Schedule only is selected, it is recommended to program a Eco action 3 hours before the scheduled start-up of the disinfection function to preheat the tank.</p>
The disinfection operation was stopped manually: [C.3] Operation > Tank was turned off during disinfection.	Do NOT stop tank operation during disinfection.

14.4 Solving problems based on error codes

If the unit runs into a problem, the user interface displays an error code. It is important to understand the problem and to take measures before resetting an error code. This should be done by a licensed installer or by your local dealer.

This chapter gives you an overview of most possible error codes and their descriptions as they appear on the user interface.





INFORMATION

See the service manual for:

- The complete list of error codes
- A more detailed troubleshooting guideline for each error

14.4.1 To display the help text in case of a malfunction

In case of a malfunction, the following will appear on the home screen depending on the severity:

- : Error
- : Malfunction

You can get a short and a long description of the malfunction as follows:

1	<p>Press the left dial to open the main menu and go to Malfunctioning.</p> <p>Result: A short description of the error and the error code is displayed on the screen.</p>	
2	<p>Press ? in the error screen.</p> <p>Result: A long description of the error is displayed on the screen.</p>	?

**WARNING**































In case F3-00, there is possible risk of refrigerant leak. Contact your installer.









14.4.2 Error codes: Overview

Error codes of the indoor unit

Error code	Description	
7H-01		Water flow problem
7H-04		Water flow problem during domestic hot water production
80-00		Returning water temperature sensor problem
81-00		Leaving water temperature sensor problem
89-01		Heat exchanger freeze-up protection activated during defrost (error)
89-02		Heat exchanger freeze-up protection activated during heating / DHW operation. (warning)
89-03		Heat exchanger freeze-up protection activated during defrost (warning)
8H-00		Abnormal increase outlet water temperature
A1-00		Zero cross detection problem
AA-01		Backup heater overheated or BUH power cable not connected
AH-00		Tank disinfection function not completed correctly
AJ-03		Too long DHW heat-up time required
CO-00		Flow sensor malfunction
EC-00		Abnormal increase tank temperature
EC-04		Tank preheating
HC-00		Tank temperature sensor problem
HJ-10		Water pressure sensor abnormality
U4-00		Indoor/outdoor unit communication problem
U5-00		User interface communication problem
U8-04		Unknown USB device
U8-05		File malfunction
U8-07		P1P2 communication error
U8-09		MMI software version {version_MMI_software} / Indoor unit [version_IU_modelname] compatibility error
U8-11		Connection with the Wireless gateway lost
UA-00		Indoor unit, outdoor unit matching problem

Error codes of the outdoor unit

Error code	Description	
A5-00		OU: High pressure peak cut / freeze protection problem
C5-00		Heat exchanger thermistor abnormality
E1-00		OU: PCB defect
E3-00		OU: Actuation of high pressure switch (HPS)
E3-24		High pressure sensor abnormality
E5-00		OU: Overheat of inverter compressor motor
E6-00		OU: Compressor startup defect
E7-00		OU: Malfunction of outdoor unit fan motor
E8-00		OU: Power input overvoltage
EA-00		OU: Cool/heat switchover problem
F3-00		OU: Malfunction of discharge pipe temperature
F6-00		OU: Abnormal high pressure in cooling
F8-00		Compressor internal error
H0-00		OU: Voltage/current sensor problem
H3-00		OU: Malfunction of high pressure switch (HPS)
H6-00		OU: Malfunction of position detection sensor
H8-00		OU: Malfunction of compressor input (CT) system
H9-00		OU: Malfunction of outdoor air thermistor
J3-00		OU: Malfunction of discharge pipe thermistor
J3-10		Compressor port thermistor abnormality
J6-00		OU: Malfunction of heat exchanger thermistor
J6-07		OU: Malfunction of heat exchanger thermistor
J6-32		Leaving water temperature thermistor Abnormality (outdoor unit)
J8-00		Malfunction of refrigerant liquid thermistor
J9-00		Malfunction of refrigerant gas thermistor
JA-00		OU: Malfunction of high pressure sensor
L1-00		Malfunction of INV PCB
L3-00		OU: Electrical box temperature rise problem
L4-00		OU: Malfunction of inverter radiating fin temperature rise
L5-00		OU: Inverter instantaneous overcurrent (DC)

Error code	Description	
L8-00		Malfunction triggered by a thermal protection in the inverter PCB
P1-00		Open-phase power supply imbalance
P4-00		OU: Malfunction of radiating fin temperature sensor
PJ-00		Capacity setting mismatch
U0-00		OU: Shortage of refrigerant
U2-00		OU: Defect of power supply voltage
U7-00		OU: Transmission malfunction between main CPU- INV CPU
UF-00		Reversed piping or bad communication wiring detection.
UH-00		Indoor unit malfunction or frost in other indoor units

Error codes of the unit



INFORMATION

In case of error code AH and no interruption of the disinfection function occurred due to domestic hot water tapping, following actions are recommended:

- When the **Reheat only** or **Schedule + reheat** mode is selected, it is recommended to program the start-up of the disinfection function at least 4 hours later than the last expected large hot water tapping. This start-up can be set by installer settings (disinfection function).
- When the **Schedule only** mode is selected, it is recommended to program an Eco action 3 hours before the scheduled start-up of the disinfection function to preheat the tank.



NOTICE

When the minimum water flow is lower than required (see "[11.4.1 Minimum flow rate](#)" [▶ 119]), the unit will temporarily stop operation and the user interface will display error 7H-01. After some time, this error will reset automatically and the unit will resume operation.



INFORMATION

When error 7H-01 occurs, you might also see 7H-08 in the malfunction list of the user interface. In this case the root cause can either be insufficient voltage towards the pump or the pump is blocked.



INFORMATION

Error AJ-03 is reset automatically from the moment there is a normal tank heat-up.



INFORMATION

If an U8-04 error occurs, the error can be reset after a successful update of the software. If the software is not successfully updated then you must make sure that your USB device has the FAT32 format.



INFORMATION

The user interface will display how to reset an error code.

15 Disposal

**NOTICE**

Do NOT try to dismantle the system yourself: dismantling of the system, treatment of the refrigerant, oil and other parts **MUST** comply with applicable legislation. Units **MUST** be treated at a specialised treatment facility for reuse, recycling and recovery.

16 Technical data

A **subset** of the latest technical data is available on the regional Daikin website (publicly accessible). The **full set** of the latest technical data is available on the Daikin Business Portal (authentication required).

In this chapter

16.1	Piping diagram: Indoor unit.....	141
16.2	Wiring diagram: Indoor unit.....	142
16.3	ESP curve: Indoor unit.....	145
16.4	Technical specifications: Domestic hot water tank.....	145
16.4.1	Test results in accordance with EN12897 (2016).....	145
16.4.2	Warning label.....	146

16.1 Piping diagram: Indoor unit

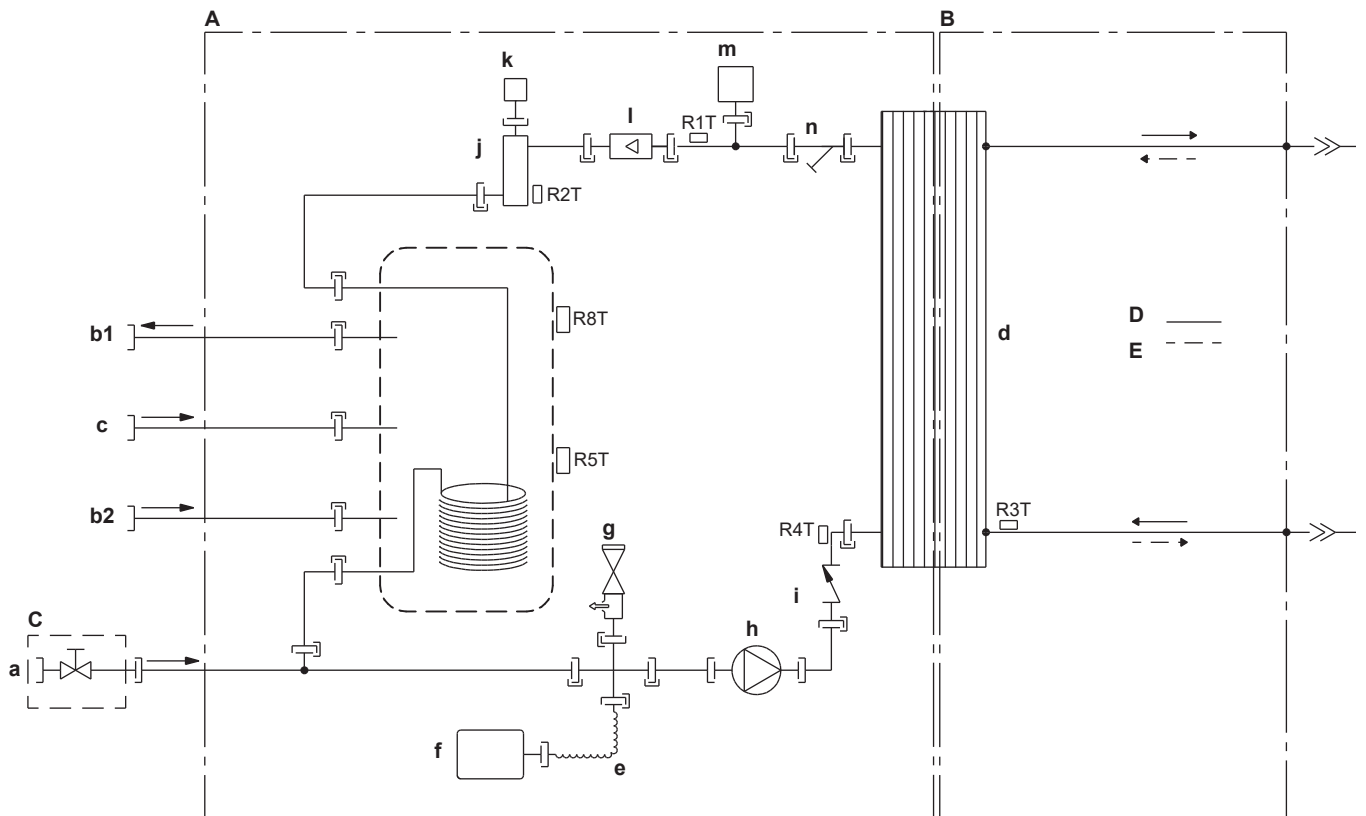



3D152607

- A** Water side
 - B** Refrigerant side
 - C** Field installed
 - D** Evaporator
 - E** Condenser
 - a** Filler pipe water inlet
 - b1** Domestic hot water: hot water out
 - b2** Domestic hot water: cold water in
 - c** Recirculation connection
 - d** Plate heat exchanger
 - e** Flexible pipe
 - f** Expansion vessel
 - g** Safety valve
 - h** Pump
 - i** Check valve
 - j** Backup heater
 - k** Automatic air purge valve
 - l** Flow sensor
 - m** Water pressure sensor
 - n** Filter
- Thermistors**
- R1T** Outlet water heat exchange thermistor
 - R2T** Outlet water backup heater thermistor
 - R3T** Thermistor (heat exchange, liquid pipe)
 - R4T** Inlet water thermistor
 - R5T** Tank thermistor
 - R8T** Tank thermistor

16.2 Wiring diagram: Indoor unit

See the internal wiring diagram supplied with the unit (on the inside of the indoor unit switch box cover). The abbreviations used are listed below.

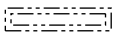
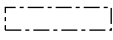
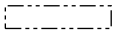
Notes to go through before starting the unit

English	Translation
Notes to go through before starting the unit	Notes to go through before starting the unit
X1M	Main terminal
X2M	Field wiring terminal for AC
X5M	Field wiring terminal for DC
X6M	Backup heater power supply terminal
-----	Earth wiring
-----	Field supply
①	Several wiring possibilities
	Option
	Not mounted in switch box
	Wiring depending on model
	PCB
Note 1: Connection point of the power supply for the BUH should be foreseen outside the unit.	Note 1: Connection point of the power supply for the backup heater should be foreseen outside the unit.
Backup heater power supply	Backup heater power supply
<input type="checkbox"/> 3V (1N~, 230 V, 1.5 kW)	<input type="checkbox"/> 3V (1N~, 230 V, 1.5 kW)
User installed options	User installed options
<input type="checkbox"/> Remote user interface	<input type="checkbox"/> Remote user interface
<input type="checkbox"/> WLAN adapter module	<input type="checkbox"/> WLAN adapter module
<input type="checkbox"/> WLAN cartridge	<input type="checkbox"/> WLAN cartridge

Position in switch box

English	Translation
Position in switch box	Position in switch box

Legend

A1P		Main PCB
A11P		Main PCB of the MMI (= user interface of the indoor unit)
A14P	*	User interface PCB
A20P	*	WLAN module
F1B	#	Overcurrent fuse backup heater
F2B	#	Overcurrent fuse main

FU1 (A1P)		Fuse T 5 A 250 V for PCB
K1M		Contactors backup heater
M2P	#	Domestic hot water pump
Q1L		Thermal protector backup heater
Q*DI	#	Earth leakage circuit breaker
R1T (A14P)	*	Ambient sensor user interface
TR1		Power supply transformer
X6M	#	Backup heater power supply terminal strip
J*, X*, X*A, X*Y		Connector
X*M		Terminal strip

- * Optional
- # Field supply

Translation of text on wiring diagram

English	Translation
(1) Main power connection	(1) Main power connection
2-pole fuse	2-pole fuse
Indoor unit supplied from outdoor (standard)	Indoor unit supplied from outdoor (standard)
Indoor unit supplied separately	Indoor unit supplied separately
Normal kWh rate power supply	Normal kWh rate power supply
Outdoor unit	Outdoor unit
(2) Backup heater power supply	(2) Backup heater power supply
2-pole fuse	2-pole fuse
Internal BUH	Internal backup heater
SWB	Switch box
(3) Options	(3) Options
Remote user interface	Remote user interface
SD card	Card slot for WLAN cartridge
SWB	Switch box
WLAN adapter module	WLAN adapter module
WLAN cartridge	WLAN cartridge
(4) Field supplied options	(4) Field supplied options
1 A (continuous)	1 A (continuous)
2 A (inrush) - 230 V AC	2 A (inrush) – 230 V AC
DHW pump	Domestic hot water pump
DHW pump output	Domestic hot water pump output
Max. load	Maximum load
SWB	Switch box

Electrical connection diagram

For more details, please check the unit wiring.

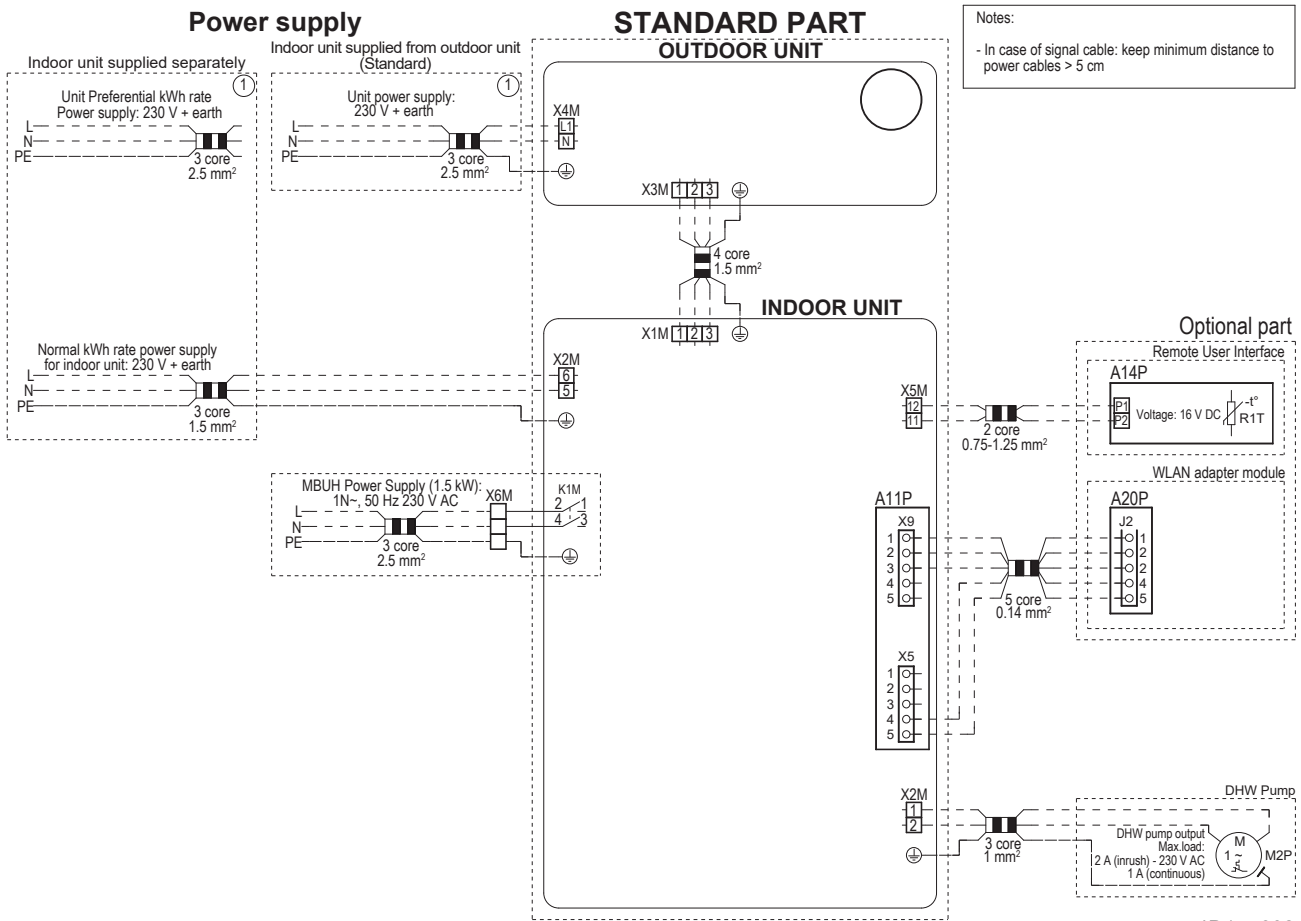

16.3 ESP curve: Indoor unit

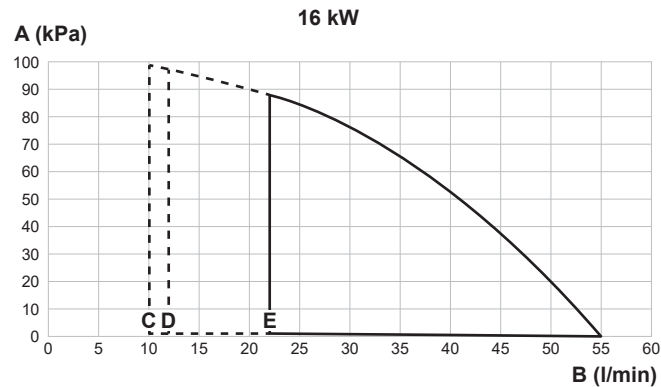
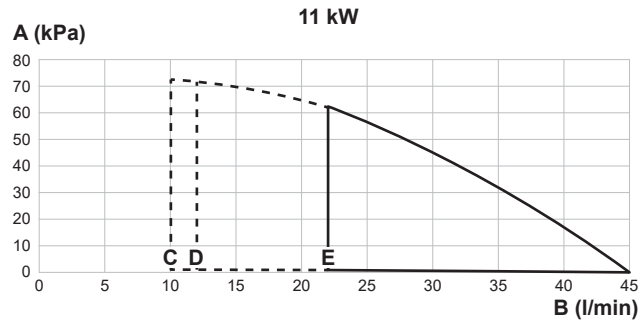

- A** External static pressure in the heating circuit
- B** Water flow rate through the unit in the heating circuit
- C** Minimum water flow rate during normal operation
- D** Minimum water flow rate during backup heater operation
- E** Minimum water flow rate during defrost operation

Notes:

- Selecting a flow outside the operating area can damage the unit or cause the unit to malfunction. See also the minimum and maximum allowed water flow range in the technical specifications.
- Make sure water quality complies with EU directive 2020/2184.

16.4 Technical specifications: Domestic hot water tank

16.4.1 Test results in accordance with EN12897 (2016)



INFORMATION

This unit has been tested and approved according to BS EN12897:2016

Description	Hot water capacity	Reheat time
CKHWSU230BJV3	207 l	22 min

16.4.2 Warning label

WARNING TO USER

- Do not remove or adjust any component part of this installation. Contact the installer.
- Should the system develop a fault, switch the system off and contact the installer.

WARNING TO INSTALLER

- This installation is subject to building regulation approval, notify Local Authority of intention to install.
- Use only manufacturer's recommended spare parts. Contact your local Daikin dealer.
- Installed by
 - name
 - address
 - tel. No.
 - completion date

TECHNICAL SPECIFICATIONS EN12897: 2016

- Maximum water supply pressure to pressure reducing valve: **12 bar**
- Operating pressure/set pressure of pressure reducing valve: **3.5 bar**
- Maximum primary working pressure (heating): **2.5 bar**
- Maximum flow temperature: **65 °C**
- Expansion vessel pre-charge pressure: **3.5 bar**
- Expansion valve setting: **8 bar**
- Temperature and pressure relief valve replacement part No.: **302810P**
- Operating pressure of temperature and pressure relief valve: **10 bar**
- Operating temperature of temperature and pressure relief valve: **95 °C**
- Operating temperature of thermal cut-out (2 pieces): **89 °C**
- Primary heating power input: **32 kW**
CKHWSU230BJV3
- Primary flow rate to reach primary heating power input: **15 l/min**
- Standing heat loss: **1.76 kWh/24h**
CKHWSU230BJV3
- Model **CKHWSU230BJV3** storage capacity **221 l** mass of unit when full **351 kg**
- Maximum design pressure: **10 bar**
- Rated volume heat exchanger: **9.1 l**

DAIKIN EUROPE N.V.

17 Glossary

Dealer

Sales distributor for the product.

Authorised installer

Technical skilled person who is qualified to install the product.

User

Person who is owner of the product and/or operates the product.

Applicable legislation

All international, European, national and local directives, laws, regulations and/or codes that are relevant and applicable for a certain product or domain.

Service company

Qualified company which can perform or coordinate the required service to the product.

Installation manual

Instruction manual specified for a certain product or application, explaining how to install, configure and maintain it.

Operation manual

Instruction manual specified for a certain product or application, explaining how to operate it.

Maintenance instructions

Instruction manual specified for a certain product or application, which explains (if relevant) how to install, configure, operate and/or maintain the product or application.

Accessories

Labels, manuals, information sheets and equipment that are delivered with the product and that need to be installed according to the instructions in the accompanying documentation.

Optional equipment

Equipment made or approved by Daikin that can be combined with the product according to the instructions in the accompanying documentation.

Field supply

Equipment NOT made by Daikin that can be combined with the product according to the instructions in the accompanying documentation.

Field settings table

Applicable indoor units

CKHWS180BJV3
CKHWS230BJV3
CKHWSU230BJV3

Notes

(*1) *180*

(*2) *230*

Field settings table				Installer setting at variance with default value		
Breadcrumb	Field code	Setting name	Range, step	Default value	Date	Value
Tank						
5.2	[6-0A]	Comfort setpoint	R/W	30-[6-0E]°C, step: 1°C 60°C		
5.3	[6-0B]	Eco setpoint	R/W	30-min(50, [6-0E])°C, step: 1°C 45°C		
5.4	[6-0C]	Reheat setpoint	R/W	30-min(50, [6-0E])°C, step: 1°C 45°C		
5.6	[6-0D]	Heat up mode	R/W	0: Reheat only 1: Reheat + sched. 2: Scheduled only		
└─ Disinfection						
5.7.1	[2-01]	Activation	R/W	0: No 1: Yes		
5.7.2	[2-00]	Operation day	R/W	0: Each day 1: Monday 2: Tuesday 3: Wednesday 4: Thursday 5: Friday 6: Saturday 7: Sunday		
5.7.3	[2-02]	Start time	R/W	0-23 hour, step: 1 hour 1		
5.7.4	[2-03]	Tank setpoint	R/W	60°C 60°C		
5.7.5	[2-04]	Duration	R/W	40-60 min, step: 5 min 40 min		
Tank						
5.8	[6-0E]	Maximum	R/W	40-65°C, step: 1°C 65°C		
5.9	[6-00]	Hysteresis	R/W	2-40°C, step: 1°C 8°C		
5.A	[6-08]	Hysteresis	R/W	2-20°C, step: 1°C 10°C		
5.B		Setpoint mode	R/W	0: Fixed 1: Weather dependent		
└─ WD curve						
5.C	[0-0B]	Leaving water value for high ambient temp. for DHW WD curve.	R/W	35-[6-0E]°C, step: 1°C 55°C		
5.C	[0-0C]	Leaving water value for low ambient temp. for DHW WD curve.	R/W	45-[6-0E]°C, step: 1°C 60°C		
5.C	[0-0D]	High ambient temp. for DHW WD curve.	R/W	10-25°C, step: 1°C 15°C		
5.C	[0-0E]	Low ambient temp. for DHW WD curve.	R/W	-40-5°C, step: 1°C -10°C		
Tank						
5.D	[6-01]	Margin	R/W	0-10°C, step: 1°C 0°C		
5.F		Priority Schedule	R/W	DHW AC		
5.G	[A-01]	Operation mode	R/W	0: Efficient 1: Quick		
5.H	[8-03]	Quick mode timer	R/W	Turbo Normal Economic		
User settings						
└─ Quiet						
7.4.1		Activation	R/W	0: OFF 1: Manual 2: Automatic		
7.4.3		Level	R/W	0: Quiet 1: More Quiet 2: Most Quiet		
Installer settings						
└─ Configuration wizard						
└─ System						
9.1.3.2	[E-03]	BUH type	R/O	2: 1.5V		
9.1.3.3	[E-05] [E-06] [E-07]	Domestic hot water	R/O	Integrated		
9.1.3.4	[4-06]	Emergency	R/W	0: Manual 1: Automatic(normal SH/DHW ON)		
└─ Backup heater						
9.1.4.1	[5-0D]	Voltage	R/O	0: 230 V, 1~		
9.1.4.2	[4-0A]	Configuration	R/O	0: 1		
9.1.4.3	[6-03]	Capacity step 1	R/O	1.5 kW		
Tank						
9.1.B.1	[6-0D]	Heat up mode	R/W	0: Reheat only 1: Reheat + sched. 2: Scheduled only		
9.1.B.2	[6-0A]	Comfort setpoint	R/W	30-[6-0E]°C, step: 1°C 60°C		
9.1.B.3	[6-0B]	Eco setpoint	R/W	30-min(50, [6-0E])°C, step: 1°C 45°C		
9.1.B.4	[6-0C]	Reheat setpoint	R/W	30-min(50, [6-0E])°C, step: 1°C 45°C		
9.1.B.6	[6-08]	Reheat hysteresis	R/W	2-20°C, step: 1°C 10°C		
└─ Domestic hot water						
9.2.1	[E-05] [E-06] [E-07]	Domestic hot water	R/O	Integrated		
9.2.2	[D-02]	DHW pump	R/W	0: No DHW pump 1: Instant hot water 2: Disinfection 3: Circulation 4: Circulation and disinfection		
└─ Back up heater						
9.3.1	[E-03]	BUH type	R/O	2: 1.5V		

Field settings table				Installer setting at variance with default value		
Breadcrumb	Field code	Setting name	Range, step	Default value	Date	Value
9.3.2	[5-0D]	Voltage	R/O	0: 230 V, 1~		
9.3.3	[4-0A]	Configuration	R/O	0: 1		
9.3.4	[6-03]	Capacity step 1	R/O	1.5 kW		
└─ Emergency						
9.5.1	[4-06]	Emergency	R/W	0: Manual 1: Automatic(normal SH/DHW ON)		
9.5.2	[7-06]	Compressor forced off	R/W	0: Disabled 1: Enabled		
└─ Energy metering						
9.A.1	[D-08]	Electricity meter 1	R/W	0: No 1: 0,1 pulse/kWh 2: 1 pulse/kWh 3: 10 pulse/kWh 4: 100 pulse/kWh 5: 1000 pulse/kWh		
└─ Sensors						
9.B.3	[1-0A]	Averaging time	R/W	0: No averaging 1: 12 hours 2: 24 hours 3: 48 hours 4: 72 hours		
Installer settings						
9.E	[3-00]	Auto restart	R/W	0: No 1: Yes		
9.F	[E-08]	Power saving function	R/W	0: Disabled 1: Enabled		
9.G		Disable protections	R/W	0: No 1: Yes		
└─ Overview field settings						
9.I	[0-0B]	Leaving water value for high ambient temp. for DHW WD curve.	R/W	35-[6-0E]°C, step: 1°C 55°C		
9.I	[0-0C]	Leaving water value for low ambient temp. for DHW WD curve.	R/W	45-[6-0E]°C, step: 1°C 60°C		
9.I	[0-0D]	High ambient temp. for DHW WD curve.	R/W	10-25°C, step: 1°C 15°C		
9.I	[0-0E]	Low ambient temp. for DHW WD curve.	R/W	-40-5°C, step: 1°C -10°C		
9.I	[1-0A]	What is the averaging time for the outdoor temp?	R/W	0: No averaging 1: 12 hours 2: 24 hours 3: 48 hours 4: 72 hours		
9.I	[2-00]	When should the disinfection function be executed?	R/W	0: Each day 1: Monday 2: Tuesday 3: Wednesday 4: Thursday 5: Friday 6: Saturday 7: Sunday		
9.I	[2-01]	Should the disinfection function be executed?	R/W	0: No 1: Yes		
9.I	[2-02]	When should the disinfection function start?	R/W	0-23 hour, step: 1 hour 1		
9.I	[2-03]	What is the disinfection target temperature?	R/O	60°C 60°C		
9.I	[2-04]	How long must the tank temperature be maintained?	R/O	40-60 min, step: 5 min 40 min		
9.I	[3-00]	Is auto restart of the unit allowed?	R/W	0: No 1: Yes		
9.I	[3-0A]	What is the pump model?	R/O	0: Pump model 0 1: Pump model 1		
9.I	[4-04]	Water pipe freeze prevention	R/W	0: Continuous pump operation 1: Non continuous pump operation 2: OFF		
9.I	[4-05]	--		0		
9.I	[4-06]	Emergency	R/W	0: Manual 1: Automatic(normal SH/DHW ON)		
9.I	[4-08]	Which power limitation mode is required on the system?	R/W	0: No limitation 1: Continuous		
9.I	[4-09]	Which power limitation type is required?	R/W	0: Current 1: Power		
9.I	[4-0A]	Backup heater configuration	R/O	0: 1		
9.I	[5-05]	What is the requested limit in amps?	R/W	0-50 A, step: 1 A 50 A		
9.I	[5-09]	What is the requested limit in kW?	R/W	0-20 kW, step: 0,5 kW 20 kW		
9.I	[5-0D]	Backup heater voltage	R/O	0: 230 V, 1~		
9.I	[5-0E]	BUH DHW thermo ON delay	R/W	0: Disable 1: Enable (variable delay HP dependent) 2: Enable (fixed delay HP dependent)		
9.I	[6-00]	The temperature difference determining the heat pump ON temperature.	R/W	2-40°C, step: 1°C 8°C		
9.I	[6-01]	The temperature difference determining the heat pump OFF temperature.	R/W	0-10°C, step: 1°C 0°C		
9.I	[6-03]	What is the capacity of the backup heater step 1?	R/O	1.5 kW		
9.I	[6-08]	What is the hysteresis to be used in reheat mode?	R/W	2-20°C, step: 1°C 10°C		
9.I	[6-0A]	What is the desired comfort storage temperature?	R/W	30-[6-0E]°C, step: 1°C 60°C		
9.I	[6-0B]	What is the desired eco storage temperature?	R/W	30-min(50, [6-0E])°C, step: 1°C 45°C		
9.I	[6-0C]	What is the desired reheat temperature?	R/W	30-min(50, [6-0E])°C, step: 1°C 45°C		
9.I	[6-0D]	What is the desired DHW production type?	R/W	0: Reheat only 1: Reheat + sched. 2: Scheduled only		

(*1) *180*

(*2) *230*

Field settings table				Installer setting at variance with default value		
Breadcrumb	Field code	Setting name	Range, step	Default value	Date	Value
9.1	[6-0E]	What is the maximum DHW temperature setpoint?	R/W	40-65°C, step: 1°C 65°C		
9.1	[7-06]	Compressor forced off	R/W	0: Disabled 1: Enabled		
9.1	[7-07]	BBR16 activation	R/W	0: Disabled 1: Enabled		
9.1	[7-08]	--	R/O	0		
9.1	[7-09]	What is the minimum pump speed during domestic hot water operation?	R/W	20-95%, step: 5% 20%		
9.1	[8-03]	Quick mode timer	R/W	20-95 min, step: 5 min 20 min		
9.1	[9-0D]	Pump speed limitation	R/W	0-8, step:1 0: No limitation 1-4: 90-60% pump speed 5-8: 90-60% pump speed during sampling 6 80% pump speed during sampling		
9.1	[9-0E]	--		6		
9.1	[D-02]	Which type of DHW pump is installed?	R/W	0: No DHW pump 1: Instant hot water 2: Disinfection 3: Circulation 4: Circulation and disinfection		
9.1	[D-08]	Is an external kWh meter used for power measurement?	R/W	0: No 1: 0,1 pulse/kWh 2: 1 pulse/kWh 3: 10 pulse/kWh 4: 100 pulse/kWh 5: 1000 pulse/kWh		
9.1	[D-0A]	--		0		
9.1	[D-0B]	--		2		
9.1	[E-00]	--		0		
9.1	[E-01]	--		0		
9.1	[E-02]	--		0		
9.1	[E-03]	What is the number of backup heater steps?	R/O	2: 1.5V		
9.1	[E-04]	Is the power saving function available on the outdoor unit?	R/O	0: No 1: Yes		
9.1	[E-05]	Can the system prepare domestic hot water?	R/O	1: Yes		
9.1	[E-06]	Is a DHW tank installed in the system?	R/O	1: Yes		
9.1	[E-07]	What kind of DHW tank is installed?	R/O	1: Integrated		
9.1	[E-08]	Power saving function for outdoor unit.	R/W	0: Disabled 1: Enabled		
9.1	[E-09]	--		1		
9.1	[E-0A]	Tank volume	R/O	180 (*1) 230 (*2)		
9.1	[E-0D]	Is glycol present in the system?	R/O	0: No 1: Yes		
9.1	[E-0E]	--		0		
9.1	[F-00]	Pump operation allowed outside range.	R/W	0: Disabled 1: Enabled		
9.1	[F-0D]	--		1		

